

N3680 Decoded Engine

User Guide

Disclaimer

Honeywell International Inc. ("HII") reserves the right to make changes in specifications and other information contained in this document without prior notice, and the reader should in all cases consult HII to determine whether any such changes have been made. The information in this publication does not represent a commitment on the part of HII.

HII shall not be liable for technical or editorial errors or omissions contained herein; nor for incidental or consequential damages resulting from the furnishing, performance, or use of this material.

This document contains proprietary information that is protected by copyright. All rights are reserved. No part of this document may be photocopied, reproduced, or translated into another language without the prior written consent of HII.

Copyright © 2015-2016 Honeywell International Inc. All rights reserved.

Other product names or marks mentioned in this document may be trademarks or registered trademarks of other companies and are the property of their respective owners.

Web Address: www.honeywellaidc.com

Microsoft® Windows® and the Windows logo are trademarks or registered trademarks of Microsoft Corporation.

Other product names or marks mentioned in this document may be trademarks or registered trademarks of other companies and are the property of their respective owners.

For patent information, refer to www.hsmpats.com.



Table of Contents

Contact Customer Support

Product Service and Repair	vii
Limited Warranty	vii
Send Feedback	vii

Chapter 1 - Getting Started

Introduction	1-1
About This Manual	1-1
Unpacking Your Device	1-1
OEM Scan Engine Models	1-1
Connecting the Development Scan Engine to the PC	1-2
Connecting with USB	1-2
Connecting with RS232 Serial Port	1-3
Reading Techniques	1-5
Menu Bar Code Security Settings	1-5
Setting Custom Defaults	1-5
Resetting the Custom Defaults	1-6

Chapter 2 - Programming the Interface

Introduction	2-1
Programming the Interface - Plug and Play	2-1
RS232 Serial Port	2-1
USB PC or Macintosh Keyboard	2-1
USB HID	2-1
USB Serial	2-2
Verifone® Ruby Terminal Default Settings	2-2
Gilbarco® Terminal Default Settings	2-3
Honeywell Bioptic Aux Port Configuration	2-3
Datalogic™ Magellan® Aux Port Configuration	2-3
NCR Bioptic Aux Port Configuration	2-3
Wincor Nixdorf Terminal Default Settings	2-4
Wincor Nixdorf Beetle™ Terminal Default Settings	2-4
Wincor Nixdorf RS232 Mode A	2-5
Keyboard Country Layout	2-6
Keyboard Style	2-13
Keyboard Conversion	2-14
Control Character Output	2-15
Keyboard Modifiers	2-15

RS232 Modifiers	2-16
RS232 Baud Rate	2-16
RS232 Word Length: Data Bits, Stop Bits, and Parity	2-17
RS232 Receiver Time-Out.....	2-18
RS232 Handshaking.....	2-18
RS232 Timeout.....	2-19
XON/XOFF	2-19
ACK/NAK	2-20
RS232 Stop Mode	2-20
Scanner to Bioptic Communication	2-20
Scanner-Biopic Packet Mode	2-20
Scanner-Biopic ACK/NAK Mode.....	2-21
Scanner-Biopic ACK/NAK Timeout.....	2-21

Chapter 3 - Input/Output Settings

Power Up Beeper	3-1
Beep on BEL Character.....	3-1
Trigger Click	3-1
Good Read and Error Indicators.....	3-2
Beeper – Good Read.....	3-2
Beeper Volume – Good Read.....	3-2
Beeper Pitch – Good Read.....	3-2
Beeper Pitch – Error	3-3
Beeper Duration – Good Read	3-3
LED – Good Read	3-3
Number of Beeps – Good Read	3-4
Number of Beeps – Error.....	3-4
Good Read Delay	3-4
User-Specified Good Read Delay.....	3-4
Manual Trigger Mode	3-5
When in manual trigger mode, the scanner scans until a bar code is read, or until the trigger is released.	3-5
LED Illumination - Manual Trigger	3-5
Character Activation Mode	3-5
Activation Character	3-5
End Character Activation After Good Read	3-6
Character Activation Timeout	3-6
Character Deactivation Mode	3-6
Deactivation Character	3-7
Serial Trigger Mode	3-7
Read Time-Out	3-7
Presentation Mode	3-7
Idle Illumination - Presentation Mode	3-8
Presentation Sensitivity	3-8
Presentation Centering.....	3-8
CodeGate®	3-10
Mobile Phone Read Mode	3-11

Poor Quality Codes	3-11
Poor Quality 1D Codes	3-11
Poor Quality PDF Codes	3-11
Hands Free Time-Out	3-12
Reread Delay	3-12
User-Specified Reread Delay	3-12
2D Reread Delay	3-13
Illumination Lights	3-13
Aimer Delay	3-14
User-Specified Aimer Delay	3-14
Aimer Mode	3-14
Centering	3-15
Output Sequence Overview	3-16
Output Sequence Editor	3-16
To Add an Output Sequence	3-16
Other Programming Selections	3-16
Output Sequence Editor	3-18
Partial Sequence	3-18
Require Output Sequence	3-18
Multiple Symbols	3-19
No Read	3-19
Video Reverse	3-19
Working Orientation	3-20

Chapter 4 - Data Editing

Prefix/Suffix Overview	4-1
To Add a Prefix or Suffix:	4-1
To Clear One or All Prefixes or Suffixes	4-2
To Add a Carriage Return Suffix to All Symbolologies	4-2
Prefix Selections	4-2
Suffix Selections	4-2
Function Code Transmit	4-3
Intercharacter, Interfunction, and Intermessage Delays	4-3
Intercharacter Delay	4-3
User Specified Intercharacter Delay	4-3
Interfunction Delay	4-4
Intermessage Delay	4-4

Chapter 5 - Data Formatting

Data Format Editor Introduction	5-1
Add a Data Format	5-1
Other Programming Selections	5-2
Terminal ID Table	5-3
Data Format Editor Commands	5-3
Move Commands	5-5
Search Commands	5-6
Miscellaneous Commands	5-7

Data Formatter	5-9
Primary/Alternate Data Formats	5-10

Chapter 6 - Symbolologies

All Symbolologies	6-1
Message Length Description	6-1
Codabar	6-2
Codabar Concatenation.....	6-3
Code 39	6-4
Code 32 Pharmaceutical (PARAF)	6-5
Full ASCII.....	6-6
Code 39 Code Page	6-6
Interleaved 2 of 5.....	6-7
NEC 2 of 5	6-8
Code 93	6-9
Code 93 Code Page	6-10
Straight 2 of 5 Industrial (three-bar start/stop).....	6-11
Straight 2 of 5 IATA (two-bar start/stop)	6-12
Matrix 2 of 5.....	6-13
Code 11	6-14
Code 128	6-15
ISBT 128 Concatenation.....	6-15
Code 128 Code Page	6-16
GS1-128	6-17
UPC-A	6-17
UPC-A/EAN-13 with Extended Coupon Code	6-19
Coupon GS1 DataBar Output.....	6-20
UPC-E0	6-20
UPC-E1	6-22
EAN/JAN-13	6-23
Convert UPC-A to EAN-13	6-23
ISBN Translate	6-25
EAN/JAN-8	6-25
MSI	6-27
GS1 DataBar Omnidirectional	6-29
GS1 DataBar Limited.....	6-29
GS1 DataBar Expanded	6-30
Codablock A	6-30
Codablock F	6-31
PDF417	6-32
MacroPDF417	6-32
MicroPDF417.....	6-33
GS1 Composite Codes.....	6-33
UPC/EAN Version.....	6-34
GS1 Emulation	6-34
TCIF Linked Code 39 (TLC39)	6-35
QR Code.....	6-35
QR Code Page	6-36

Data Matrix	6-37
Data Matrix Code Page	6-37
MaxiCode	6-38
Aztec Code	6-39
Aztec Code Page.....	6-39
Chinese Sensible (Han Xin) Code	6-40
Postal Codes - 2D	6-41
Single 2D Postal Codes:.....	6-41
Combination 2D Postal Codes:.....	6-42
Postal Codes - Linear	6-45
China Post (Hong Kong 2 of 5).....	6-45
Korea Post.....	6-46

Chapter 7 - Imaging Commands

Single-Use Basis	7-1
Command Syntax	7-1
Image Snap - IMGSNP	7-1
IMGSNP Modifiers	7-1
Image Ship - IMGSHIP	7-3
IMGSHIP Modifiers	7-3

Chapter 8 - Utilities

To Add a Test Code I.D. Prefix to All Symbologies	8-1
Show Decoder Revision	8-1
Show Scan Driver Revision	8-1
Show Software Revision.....	8-1
Show Data Format.....	8-1
Test Menu.....	8-2
EZConfig-Scanning Introduction.....	8-2
Installing EZConfig-Scanning from the Web.....	8-2
Resetting the Factory Defaults	8-3

Chapter 9 - Serial Programming Commands

Conventions.....	9-1
Menu Command Syntax	9-1
Serial Command Example	9-1
Query Commands	9-1
Responses.....	9-2
Trigger Commands.....	9-3
Setting the Custom Defaults	9-3
Resetting the Custom Defaults	9-3
Menu Commands	9-4

Chapter 10 - Maintenance and Troubleshooting

Repairs	10-1
Inspecting Cords and Connectors	10-1

Troubleshooting.....	10-1
----------------------	------

Appendix A - Reference Charts

Symbology Charts	A-1
Linear Symbologies	A-1
2D Symbologies.....	A-3
Postal Symbologies	A-3
ASCII Conversion Chart (Code Page 1252).....	A-3
Lower ASCII Reference Table.....	A-4
ISO 2022/ISO 646 Character Replacements	A-8
Keyboard Key References.....	A-10

Sample Symbols

Programming Chart

Contact Customer Support

To search our knowledge base for a solution or to log in to the Technical Support portal and report a problem, go to www.hsmcontactsupport.com.

For our latest contact information, see www.honeywellaidc.com/locations.

Product Service and Repair

Honeywell International Inc. provides service for all of its products through service centers throughout the world. To find your service center, go to www.honeywellaidc.com and select **Support**. Contact your service center to obtain a Return Material Authorization number (RMA #) before you return the product.

To obtain warranty or non-warranty service, return your product to Honeywell (postage paid) with a copy of the dated purchase record. Limited Warranty

Limited Warranty

For warranty information, go to www.honeywellaidc.com and click **Get Resources > Product Warranty**.

Send Feedback

Your feedback is crucial to the continual improvement of our documentation. To provide feedback about this manual, contact the Honeywell Technical Communications department at ACSHSMTechnicalCommunications@honeywell.com.



Getting Started

Introduction

The N36XX scan engine is designed for integration into a wide range of OEM devices. The scan engine's compact mechanical design can drop into many existing applications, allowing OEMs and third-party manufacturers to integrate the benefits of image-based scanning into a variety of devices, including hand held computers, PDTs, medical instrumentation, kiosks, diagnostic equipment, and robotics. The N36XX unit decodes linear, 2D, and postal codes.

About This Manual

This User's Guide provides demonstration, installation, and programming instructions for the N36XX scan engine.

Honeywell's bar code scan engines are factory programmed for the most common terminal and communications settings. If you need to change these setting, programming is accomplished by scanning the bar codes in this guide.

An asterisk (*) next to an option indicates the default setting.

Unpacking Your Device

After you open the shipping carton containing the OEM scan engine(s), take the following steps:

- Check for damage during shipment. Report damage immediately to the carrier who delivered the carton.
- Make sure the items in the carton match your order.
- Save the shipping container for later storage or shipping.

OEM Scan Engine Models

There are two models of the OEM scan engine, which may be used with the interfaces described in this manual. Refer to the chart below to determine the models that can be used with your interface.

Models	Interface	Decoding Capability
N3680SR-W1-TTL	TTL Level 232	Linear, 2D, postal
N3680SR-W1-USB	Full-Speed USB	Linear, 2D, postal

Connecting the Development Scan Engine to the PC

The development OEM scan engine can connect to a PC for evaluation.

Connecting with USB

Note: The N3680XX-XX-USB scan engine will only communicate USB through the 10 pin modular connector.

1. Turn off power to the terminal/computer.
2. If using full-speed USB, connect the USB interface cable to the interface board and to the matching USB port on the computer.

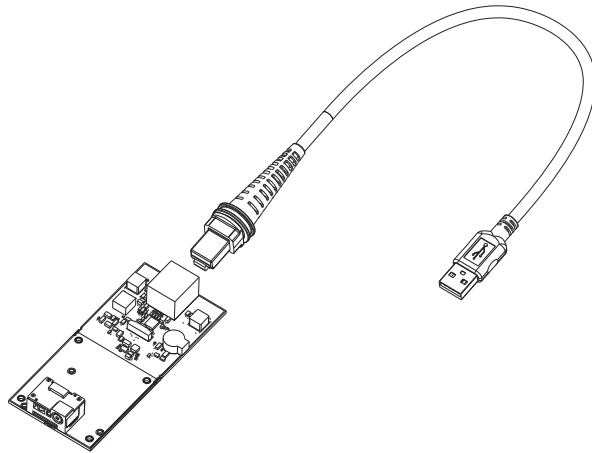

3. Verify the scan engine operation by scanning a bar code from the [Sample Symbols](#) in the back of this manual. The scan engine beeps once when a bar code is successfully decoded.

Note: The default interface is USB Keyboard (PC). If you change to USB Serial, you will need to install the USB driver. See ["USB Serial" on page 2-2](#).

Connecting with RS232 Serial Port

1. If using an RS-232 connection, connect the serial interface cable to the interface board and to the matching port on the back of the computer.

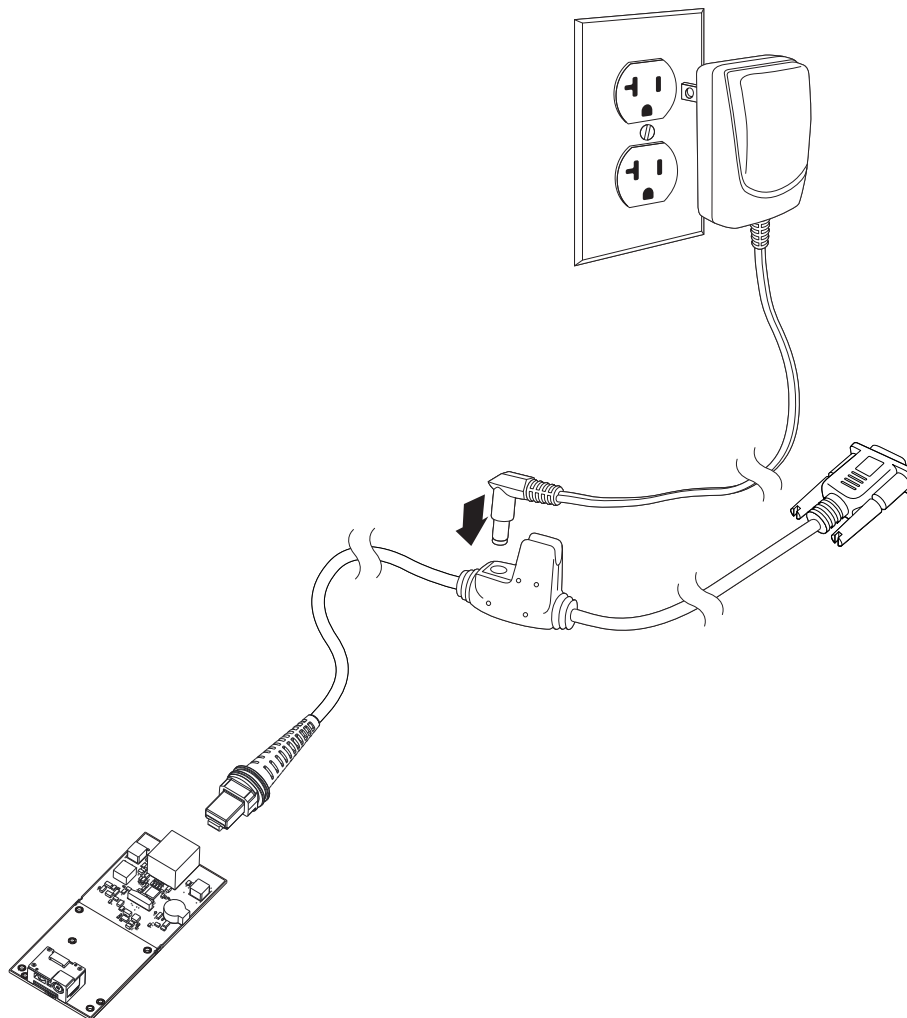

2. Connect the power supply connector to the serial interface cable. Plug in the power supply.
3. Turn the terminal/computer power back on. The scan engine beeps.
4. If connecting the scan engine using an RS-232 interface, all communication parameters between the scan engine and terminal must match for correct data transfer through the serial port using RS-232 protocol. Scan the RS-232 interface bar code below. This programs the scan engine for an RS-232 interface at 115,200 baud, parity–none, 8 data bits, 1 stop bit, and adds a suffix of a CR LF.



TERMID0;232BAD9;232WRD2

RS-232 Interface

-
5. Verify the scan engine operation by scanning a bar code from the [Sample Symbols](#) in the back of this manual. The scan engine beeps once when a bar code is successfully decoded.

To connect an scan engine to your host system, refer to the N36XX Integration Manual.

Reading Techniques

The scan engine has a view finder that projects a bright red aiming square. The aiming beam should be centered over the bar code, but it can also be positioned outside of the center for a good read.

Linear bar code



2D Matrix symbol



The aiming beam is smaller when the scan engine is closer to the code and larger when it is farther from the code. Symbologies with smaller bars or elements (mil size) should be read closer to the unit. Symbologies with larger bars or elements (mil size) should be read farther from the unit. To read single or multiple symbols (on a page or on an object), hold the scan engine at an appropriate distance from the target, pull the trigger, and center the aiming beam on the symbol. If the code being scanned is highly reflective (e.g., laminated), it may be necessary to tilt the code up 15° to 18° to prevent unwanted reflection.

Menu Bar Code Security Settings

Honeywell scan engines are programmed by scanning menu bar codes or by sending serial commands to the scan engine. If you want to restrict the ability to scan menu codes, you can use the Menu Bar Code Security settings. Contact your Honeywell OEM representative for more information.

Setting Custom Defaults

You have the ability to create a set of menu commands as your own, custom defaults. To do so, scan the **Set Custom Defaults** bar code below before scanning the menu commands for your custom defaults. If a menu command requires scanning numeric codes from the back cover, then a **Save** code, that entire sequence will be saved to your custom defaults. When you have entered all the commands you want to save for your custom defaults, scan the **Save Custom Defaults** bar code.



MNUCDP.
Set Custom Defaults



MNUCDS.
Save Custom Defaults

You may have a series of custom settings and want to correct a single setting. To do so, just scan the new setting to overwrite the old one. For example, if you had previously saved the setting for Beeper Volume at Low to your custom defaults, and decide

you want the beeper volume set to High, just scan the **Set Custom Defaults** bar code, then scan the Beeper Volume High menu code, and then **Save Custom Defaults**. The rest of the custom defaults will remain, but the beeper volume setting will be updated.

Resetting the Custom Defaults

If you want the custom default settings restored to your scan engine, scan the **Activate Custom Defaults** bar code below. This is the recommended default bar code for most users. It resets the scan engine to the custom default settings. If there are no custom defaults, it will reset the scan engine to the factory default settings. Any settings that have not been specified through the custom defaults will be defaulted to the factory default settings.



DEFAULT.

Activate Custom Defaults

Note: To remove custom defaults, see ["Resetting the Factory Defaults" on page 8-3.](#)

Programming the Interface

Introduction

This chapter describes how to program your system for the desired interface.

Programming the Interface - Plug and Play

Plug and Play bar codes provide instant scan engine set up for commonly used interfaces.

Note: After you scan one of the codes, power cycle the host terminal to have the interface in effect.

RS232 Serial Port

The **RS232 Interface** bar code is used when connecting to the serial port of a PC or terminal. The following **RS232 Interface** bar code also programs a carriage return (CR) and a line feed (LF) suffix, baud rate, and data format as indicated below. It also changes the trigger mode to manual.

Option	Setting
Baud Rate	115,200 bps
Data Format	8 data bits, no parity bit, 1 stop bit



TERMID0;232BAD9;232WRD2

RS-232 Interface

USB PC or Macintosh Keyboard

Scan one of the following codes to program the scan engine for USB PC Keyboard or USB Macintosh Keyboard. Scanning these codes also adds a CR suffix. *Default = USB Keyboard (PC).*



TERMID124.

*USB Keyboard (PC)



TERMID125.

USB Keyboard (Mac)

USB HID

Scan the following code to program the scan engine for USB HID bar code scanners.



TERMID131.

USB HID Bar Code Scanner

USB Serial

Scan the following code to program the scan engine to emulate a regular RS232-based COM Port. If you are using a Microsoft® Windows® PC, you will need to download a driver from the Honeywell website (www.honeywellaidc.com). The driver will use the next available COM Port number. Apple® Macintosh computers recognize the scan engine as a USB CDC class device and automatically use a class driver.



USB Serial

Note: No extra configuration (e.g., baud rate) is necessary.

ACK/NAK Mode



Verifone® Ruby Terminal Default Settings

Scan the following Plug and Play code to program the scan engine for a Verifone Ruby terminal. This bar code sets the baud rate to 1200 bps and the data format to 8 data bits, no parity bit, 1 stop bit. It also adds a line feed (LF) suffix and programs the following prefixes for each symbology:

Symbology	Prefix
UPC-A	A
UPC-E	A
EAN-8	FF
EAN-13	F



Gilbarco® Terminal Default Settings

Scan the following Plug and Play code to program the scan engine for a Gilbarco terminal. This bar code sets the baud rate to 2400 bps and the data format to 7 data bits, even parity, 2 stop bits. It also adds a carriage return (CR) suffix and programs the following prefixes for each symbology:

Symbology	Prefix
UPC-A	A
UPC-E	E0
EAN-8	FF
EAN-13	F



PAPGLB.
Gilbarco Settings

Honeywell Bioptic Aux Port Configuration

Scan the following Plug and Play code to program the scan engine for a Honeywell bioptic scanner auxiliary port configuration. This bar code sets the baud rate to 38400 bps and the data format to 8 data bits, no parity, 1 stop bit.



PAPBIO.
Honeywell Bioptic Settings

Datalogic™ Magellan® Aux Port Configuration

Scan the following Plug and Play code to program the scan engine for a Datalogic Magellan auxiliary port configuration. This bar code sets the baud rate to 9600 bps and the data format to 8 data bits, no parity, 1 stop bit.



PAPMAG.
Datalogic Magellan Bioptic Settings

NCR Bioptic Aux Port Configuration

Scan the following Plug and Play code to program the scan engine for an NCR bioptic scanner auxiliary port configuration. The following prefixes are programmed for each symbology:

Symbology	Prefix	Symbology	Prefix
UPC-A	A	Interleaved 2 of 5	b
UPC-E	E0	Code 128	f
EAN-8	FF	GS1 DataBar Omnidirectional	r
EAN-13	F	GS1 DataBar Expanded	r
Code 39	a	Codabar	N
		Code 32 Pharmaceutical (PARAF)	a



PAPNCR.
NCR Bioptic Settings

Wincor Nixdorf Terminal Default Settings

Scan the following Plug and Play code to program the scan engine for a Wincor Nixdorf terminal. This bar code sets the baud rate to 9600 bps and the data format to 8 data bits, no parity, 1 stop bit.



PAPWNX.
Wincor Nixdorf Terminal Settings

Wincor Nixdorf Beetle™ Terminal Default Settings

Scan the following Plug and Play code to program the scanner for a Wincor Nixdorf Beetle terminal. The following prefixes are programmed for each symbology:

Symbology	Prefix	Symbology	Prefix
Aztec Code	V	Interleaved 2 of 5	I
Codabar	N	MaxiCode	T
Code 93	L	MicroPDF417	S
Code 128	K	PDF417	Q
Data Matrix	R	QR Code	U
EAN-8	B	Straight 2 of 5 IATA	H
EAN-13	A	UPC-A	A0
GS1 DataBar	E	UPC-E	C
GS1-128	P	All other bar codes	M



PAPBTL.
Wincor Nixdorf Beetle Settings

Wincor Nixdorf RS232 Mode A

Scan the following Plug and Play code to program the scanner for a Wincor Nixdorf RS232 Mode A terminal. This bar code sets the baud rate to 9600 bps and the data format to 8 data bits, odd parity, 1 stop bit. The following prefixes are programmed for each symbology:

Symbology	Prefix	Symbology	Prefix
Code 128	K	EAN-13	A
Code 93	L	GS1-128	K
Codabar	N	Interleaved 2 of 5	I
UPC-A	A0	Plessey	O
UPC-E	C	Straight 2 of 5 IATA	H
EAN-8	B	GS1 DataBar	E
All other bar codes	M		



PAPWMA

**Wincor Nixdorf RS232 Mode A
Settings**

Keyboard Country Layout

Scan the appropriate country code below to program the keyboard layout for your country or language. As a general rule, the following characters are supported, but need special care for countries other than the United States:
@ | \$ # { } [] = / ' \ < > ~

Keyboard Countries



KBDCTY0.
* United States



KBDCTY35.
Albania



KBDCTY81.
Azeri (Cyrillic)



KBDCTY80.
Azeri (Latin)



KBDCTY82.
Belarus



KBDCTY1.
Belgium



KBDCTY33.
Bosnia



KBDCTY16.
Brazil



KBDCTY59.
Brazil (MS)



KBDCTY52.
Bulgaria (Cyrillic)

Keyboard Countries (Continued)



KBDCTY53.
Bulgaria (Latin)



KBDCTY18.
Canada (French)



KBDCTY32.
Croatia



KBDCTY40.
Czech (Programmers)



KBDCTY38.
Czech (QWERTZ)



KBDCTY11.
Dutch (Netherlands)



KBDCTY54.
Canada (French legacy)



KBDCTY55.
Canada (Multilingual)



KBDCTY15.
Czech



KBDCTY39.
Czech (QWERTY)



KBDCTY8.
Denmark

Keyboard Countries (Continued)



KBDCTY83.
Faroese



KBDCTY3.
France



KBDCTY4.
Germany



KBDCTY64.
Greek (220 Latin)



KBDCTY65.
Greek (319 Latin)



KBDCTY41.
Estonia



KBDCTY2.
Finland



KBDCTY84.
Gaelic



KBDCTY17.
Greek



KBDCTY61.
Greek (220)



KBDCTY62.
Greek (319)

Keyboard Countries (Continued)



KBDCTY63.
Greek (Latin)



KBDCTY60.
Greek (Polytonic)



KBDCTY50.
Hungarian (101 key)



KBDCTY75.
Iceland



KBDCTY56.
Italian (142)



KBDCTY28.
Japan ASCII



KBDCTY66.
Greek (MS)



KBDCTY12.
Hebrew



KBDCTY19.
Hungary



KBDCTY73.
Irish



KBDCTY5.
Italy

Keyboard Countries (Continued)



KBDCTY79.
Kyrgyz (Cyrillic)



KBDCTY42.
Latvia



KBDCTY44.
Lithuania



KBDCTY34.
Macedonia



KBDCTY86.
Mongolian (Cyrillic)



KBDCTY78.
Kazakh



KBDCTY14.
Latin America



KBDCTY43.
Latvia (QWERTY)



KBDCTY45.
Lithuania (IBM)



KBDCTY74.
Malta



KBDCTY9.
Norway

Keyboard Countries (Continued)



KBDCTY20.
Poland



KBDCTY58.
Polish (Programmers)



KBDCTY25.
Romania



KBDCTY67.
Russian (MS)



KBDCTY21.
SCS



KBDCTY36.
Serbia (Latin)



KBDCTY57.
Polish (214)



KBDCTY13.
Portugal



KBDCTY26.
Russia



KBDCTY68.
Russian (Typewriter)



KBDCTY37.
Serbia (Cyrillic)

Keyboard Countries (Continued)



KBDCTY49.
Slovakia (QWERTY)



KBDCTY31.
Slovenia



KBDCTY51.
Spanish variation



KBDCTY29.
Switzerland (French)



KBDCTY85.
Tatar



KBDCTY22.
Slovakia



KBDCTY48.
Slovakia (QWERTZ)



KBDCTY10.
Spain



KBDCTY23.
Sweden



KBDCTY6.
Switzerland (German)



KBDCTY27.
Turkey F

Keyboard Countries (Continued)



KBDCTY24.
Turkey Q



KBDCTY76.
Ukrainian



KBDCTY7.
United Kingdom



KBDCTY87.
United States (Dvorak)



KBDCTY88.
United States (Dvorak left)



KBDCTY89.
United States (Dvorak right)



KBDCTY30.
United States (International)



KBDCTY77.
Uzbek (Cyrillic)

Keyboard Style

This program's keyboard styles, such as Caps Lock and Shift Lock. If you have used [Keyboard Conversion](#) settings, they will override any of the following Keyboard Style settings. *Default = Regular.*

Regular is used when you normally have the Caps Lock key off.



KBDSTY0.
* Regular

Caps Lock is used when you normally have the Caps Lock key on.



KBDSTY1.
Caps Lock

Shift Lock is used when you normally have the Shift Lock key on (not common to U.S. keyboards).



Automatic Caps Lock is used if you change the Caps Lock key on and off. The software tracks and reflects if you have Caps Lock on or off. This selection can only be used with systems that have an LED that notes the Caps Lock status (AT keyboards).



Autocaps via NumLock bar code should be scanned in countries (e.g., Germany, France) where the Caps Lock key cannot be used to toggle Caps Lock. The NumLock option works similarly to the regular Autocaps, but uses the NumLock key to retrieve the current state of the Caps Lock.



Emulate External Keyboard should be scanned if you do not have an external keyboard (IBM AT or equivalent).



Note: After scanning the Emulate External Keyboard bar code, you must power cycle your computer.

Keyboard Conversion

Alphabetic keyboard characters can be forced to be all upper case or all lowercase. So if you have the following bar code: "abc569GK," you can make the output "ABC569GK" by scanning **Convert All Characters to Upper Case**, or to "abc569gk" by scanning **Convert All Characters to Lower Case**.

These settings override [Keyboard Style](#) selections.

Note: If your interface is a keyboard wedge, first scan the menu code for [Automatic Caps Lock](#) (page 2-14). Otherwise, your output may not be as expected.

Default = Keyboard Conversion Off.



Control Character Output

This selection sends a text string instead of a control character. For example, when the control character for a carriage return is expected, the output would display [CR] instead of the ASCII code of 0D. Refer to [ASCII Conversion Chart \(Code Page 1252\)](#) on page A-3. Only codes 00 through 1F are converted (the first column of the chart).

Note: Control + X (Control + ASCII) Mode overrides this mode.

Default = Off.



KBDNPE1.

Control Character Output On



KBDNPE0.

*** Control Character Output Off**

Keyboard Modifiers

This modifies special keyboard features, such as CTRL+ ASCII codes and Turbo Mode.

Control + X (Control + ASCII) Mode On: The scan engine sends key combinations for ASCII control characters for values 00-1F. Windows is the preferred mode. All keyboard country codes are supported. DOS mode is a legacy mode, and it does not support all keyboard country codes. New users should use the Windows mode. Refer to [ASCII Conversion Chart \(Code Page 1252\)](#), page A-3 for CTRL+ X Values.

Windows Mode Prefix/Suffix Off: The scan engine sends key combinations for ASCII control characters for values 00-1F, but it does not translate any prefix or suffix information.

Default = Control + X Mode Off.



KBDCAS2.

Windows Mode Control + X Mode On



KBDCAS0.

*** Control + X Mode Off**



KBDCAS1.

DOS Mode Control + X Mode On



KBDCAS3.

Windows Mode Prefix/Suffix Off

Turbo Mode: The scan engine sends characters to a terminal faster. If the terminal drops characters, do not use Turbo Mode.

Default = Off



KBDTMD1.

Turbo Mode On



KBDTMD0.
* Turbo Mode Off

Numeric Keypad Mode: Sends numeric characters as if entered from a numeric keypad. *Default = Off*



KBDNPS1.
Numeric Keypad Mode On



KBDNPS0.
* Numeric Keypad Mode Off

Automatic Direct Connect Mode: This selection can be used if you have an IBM AT style terminal and the system is dropping characters. *Default = Off*



KBDADC1.
Automatic Direct Connect Mode
On



KBDADC0.
* Automatic Direct Connect
Mode Off

RS232 Modifiers

RS232 Baud Rate

Baud Rate sends the data from the scan engine to the terminal at the specified rate. The host terminal must be set for the same baud rate as the scan engine. *Default = 115200.*



232BAD0.
300



232BAD1.
600



232BAD2.
1200



RS232 Word Length: Data Bits, Stop Bits, and Parity

Data Bits sets the word length at 7 or 8 bits of data per character. If an application requires only ASCII Hex characters 0 through 7F decimal (text, digits, and punctuation), select 7 data bits. For applications that require use of the full ASCII set, select 8 data bits per character. *Default = 8.*

Stop Bits sets the stop bits at 1 or 2. *Default = 1.*

Parity provides a means of checking character bit patterns for validity. *Default = None.*





232WRD1.

7 Data, 2 Stop Parity None



232WRD5.

8 Data, 1 Stop, Parity Even



232WRD8.

8 Data, 1 Stop, Parity Odd



232WRD4.

7 Data, 2 Stop, Parity Even



232WRD7.

7 Data, 2 Stop, Parity Odd



232WRD2.

* 8 Data, 1 Stop, Parity None



232WRD14.

8 Data, 1 Stop, Parity Mark

RS232 Receiver Time-Out

The unit stays awake to receive data until the RS232 Receiver Time-Out expires. A manual or serial trigger resets the time-out. When an RS232 receiver is sleeping, a character may be sent to wake up the receiver and reset the time-out. A transaction on the CTS line will also wake up the receiver. The receiver takes 300 milliseconds to completely come up. Change the RS232 receiver time-out by scanning the bar code below, then scanning digits from the inside back cover of this manual, then scanning **Save**. The range is 0 to 300 seconds. *Default = 0 seconds (no time-out - always on).*



232LPT.

RS232 Receiver Time-Out

RS232 Handshaking

RS232 Handshaking allows control of data transmission from the scan engine using software commands from the host device. When RTS/CTS is turned **Off**, no data flow control is used.

Flow Control, No Timeout: The scan engine asserts RTS when it has data to send, and will wait indefinitely for CTS to be asserted by the host.

Two-Direction Flow Control: The scan engine asserts RTS when it is OK for the host to transmit. The host asserts CTS when it is OK for the device to transmit.

Flow Control with Timeout: The scan engine asserts RTS when it has data to send and waits for a delay (see [RS232 Timeout](#) on page 2-19) for CTS to be asserted by the host. If the delay time expires and CTS is not asserted, the device transmit buffer is cleared and scanning may resume.

Default = RTS/CTS Off.



232CTS1.

Flow Control, No Timeout



232CTS2.

Two-Direction Flow Control



232CTS3.

Flow Control with Timeout



232CTS0.

*** RTS/CTS Off**

RS232 Timeout

When using Flow Control with Timeout, you must program the length of the delay you want to wait for CTS from the host. Set the length (in milliseconds) for a timeout by scanning the bar code below, then setting the timeout (from 1-5100 milliseconds) by scanning digits from the inside back cover, then scanning **Save**.



232DEL.

RS232 Timeout

XON/XOFF

Standard ASCII control characters can be used to tell the scan engine to start sending data (**XON/XOFF On**) or to stop sending data (**XON/XOFF Off**). When the host sends the XOFF character (DC3, hex 13) to the scan engine, data transmission stops. To resume transmission, the host sends the XON character (DC1, hex 11). Data transmission continues where it left off when XOFF was sent. *Default = XON/XOFF Off.*



232XON1.

XON/XOFF On



232XON0.

*** XON/XOFF Off**

ACK/NAK

After transmitting data, the scan engine waits for an ACK character (hex 06) or a NAK character (hex 15) response from the host. If ACK is received, the communications cycle is completed and the scan engine looks for more bar codes. If NAK is received, the last set of bar code data is retransmitted and the scan engine waits for ACK/NAK again. Turn on the ACK/NAK protocol by scanning the **ACK/NAK On** bar code below. To turn off the protocol, scan **ACK/NAK Off**. *Default = ACK/NAK Off.*



232ACK1.
ACK/NAK On



232ACK0.
*** ACK/NAK Off**

RS232 Stop Mode

Scan the following bar code to force the engine into a stop mode. Restart the engine by using a trigger pull, nWake, or RxD toggle.



232SDY.
RS232 Stop Mode On

Scanner to Bioptic Communication

The following settings are used to set up communication between Honeywell scan engines and bioptic scanners.

Note: The scan engine's baud rate must be set to 38400 and the RS232 timeout must be set to 3000 in order to communicate with a bioptic scanner. See "RS232 Baud Rate" on page 2-16, and [RS232 Timeout](#) on page 2-19 for further information.

Scanner-Bioptic Packet Mode

Packet Mode On must be scanned to set the scan engine's format so it is compatible with a bioptic scanner. *Default = Packet Mode Off.*



232PKT0.
*** Packet Mode Off**



232PKT2.
Packet Mode On

Scanner-Bioptic ACK/NAK Mode

Bioptic ACK/Nak On must be scanned so the scan engine will wait for an ACK or NAK from a bioptic scanner after each packet is sent. The Scanner-Bioptic ACK/NAK Timeout (below) controls how long the scanner will wait for a response.
Default = Bioptic ACK/NAK Off.



232NAK0.
*** Bioptic ACK/NAK Off**



232NAK1.
Bioptic ACK/NAK On

Scanner-Bioptic ACK/NAK Timeout

This allows you to set the length (in milliseconds) for a timeout for a bioptic scanner's ACK/NAK response. Scan the bar code below, then set the timeout (from 1-30,000 milliseconds) by scanning digits from the inside back cover, then scanning **Save**. *Default = 5100.*



232DLK.
ACK/NAK Timeout



Input/Output Settings

Power Up Beeper

The scan engine can be programmed to beep when it's powered up. Scan the **Off** bar code(s) if you don't want a power up beep. *Default = Power Up Beeper On - Scanner.*



BEPPWR0.
Power Up Beeper Off -
Scanner



BEPPWR1.
* Power Up Beeper On -
Scanner

Beep on BEL Character

You may wish to force the scan engine to beep upon a command sent from the host. If you scan the **Beep on BEL On** bar code below, the scan engine will beep every time a BEL character is received from the host. *Default = Beep on BEL Off.*



BELBEP0.
*Beep on BEL Off



BELBEP1.
Beep on BEL On

Trigger Click

To hear an audible click every time the scanner trigger is pressed, scan the **Trigger Click On** bar code below. Scan the **Trigger Click Off** code if you don't wish to hear the click. (This feature has no effect on serial or automatic triggering.) *Default = Trigger Click Off.*



BEPTRG0.
*Trigger Click Off



BEPTRG1.
Trigger Click On

Good Read and Error Indicators

Beeper – Good Read

The beeper may be programmed **On** or **Off** in response to a good read. Turning this option off only turns off the beeper response to a good read indication. All error and menu beeps are still audible. *Default = Beeper - Good Read On.*



BEPBEP0.
Beeper - Good Read Off



BEPBEP1.
* Beeper - Good Read On

Beeper Volume – Good Read

The beeper volume codes modify the volume of the beep the scan engine emits on a good read. *Default = High.*



BEPLVL1.
Low



BEPLVL2.
Medium



BEPLVL3.
* High



BEPLVL0.
Off

Beeper Pitch – Good Read

The beeper pitch codes modify the pitch (frequency) of the beep the scan engine emits on a good read. *Default = Medium.*



BEPFQ11600.
Low (1600 Hz)



BEPFQ12700.
* Medium (2700 Hz)



BEPFQ14200.
High (4200 Hz)

Beeper Pitch – Error

The beeper pitch codes modify the pitch (frequency) of the sound the scan engine emits when there is a bad read or error. *Default = Razz.*



BEPFQ2250.
* Razz (250 Hz)



BEPFQ23250.
Medium (3250 Hz)



BEPFQ24200.
High (4200 Hz)

Beeper Duration – Good Read

The beeper duration codes modify the length of the beep the scan engine emits on a good read. *Default = Normal.*



BEPBIP0.
* Normal Beep



BEPBIP1.
Short Beep

LED – Good Read

The LED indicator can be programmed **On** or **Off** in response to a good read. *Default = On.*



BEPLED1.
* LED - Good Read On



BEPLED0.
LED - Good Read Off

Number of Beeps – Good Read

The number of beeps of a good read can be programmed from 1 - 9. The same number of beeps will be applied to the beeper and LED in response to a good read. For example, if you program this option to have five beeps, there will be five beeps and five LED flashes in response to a good read. The beeps and LED flashes are in sync with one another. To change the number of beeps, scan the bar code below and then scan a digit (1-9) bar code and the **Save** bar code on the [Programming Chart](#) inside the back cover of this manual. *Default = 1.*



BEPRPT.

Number of Good Read Beeps/LED Flashes

Number of Beeps – Error

The number of beeps and LED flashes emitted by the scan engine for a bad read or error can be programmed from 1 - 9. For example, if you program this option to have five error beeps, there will be five error beeps and five LED flashes in response to an error. To change the number of error beeps, scan the bar code below and then scan a digit (1-9) bar code and the **Save** bar code on the [Programming Chart](#) inside the back cover of this manual. *Default = 1.*



BEPERR.

Number of Error Beeps/LED Flashes

Good Read Delay

This sets the minimum amount of time before the scan engine can read another bar code. *Default = 0 ms (No Delay).*



DLYGRD0.

* No Delay



DLYGRD500.

Short Delay (500 ms)



DLYGRD1000.

Medium Delay (1,000 ms)



DLYGRD1500.

Long Delay (1,500 ms)

User-Specified Good Read Delay

If you want to set your own length for the good read delay, scan the bar code below, then set the delay (from 0-30,000 milliseconds) by scanning digits from the inside back cover, then scanning **Save**.



DLYGRD.

User-Specified Good Read Delay

Manual Trigger Mode

When in manual trigger mode, the scanner scans until a bar code is read, or until the trigger is released.



Manual Trigger - Normal

LED Illumination - Manual Trigger

If you wish to set the illumination LED brightness, scan one of the bar codes below. This sets the LED illumination for the scan engine when the trigger is pressed. *Default = High.*

Note: The LEDs are like a flash on a camera. The lower the ambient light in the room, the brighter the LEDs need to be so the scan engine can “see” the bar codes.



Low



* High

Character Activation Mode

You may use a character sent from the host to trigger the scanner to begin scanning. When the activation character is received, the scanner continues scanning until either the [Character Activation Timeout](#) (page 3-6), the deactivation character is received (see [Deactivation Character](#) on page 3-7), or a bar code is transmitted. Scan the following **On** bar code to use character activation, then use Activation Character (following) to select the character you will send from the host to start scanning. *Default = Off.*



* Off



On

Activation Character

This sets the character used to trigger scanning when using Character Activation Mode. On the [ASCII Conversion Chart \(Code Page 1252\)](#), page A-3, find the hex value that represents the character you want to use to trigger scanning. Scan the following bar code, then use the [Programming Chart](#) to read the alphanumeric combination that represents that ASCII character. Scan **Save** to finish. *Default = 12 [DC2].*



Activation Character

End Character Activation After Good Read

After a bar code is successfully detected and read from the scanner, the illumination can be programmed either to remain on and scanning, or to turn off. When **End Character Activation After Good Read** is enabled, the illumination turns off and stops scanning after a good read. If you scan **Do Not End Character Activation After Good Read**, the illumination remains on after a good read. *Default = Do Not End Character Activation After Good Read.*



HSTCGD0.

* Do Not End Character
Activation After Good Read



HSTCGD1.

End Character Activation After
Good Read

Character Activation Timeout

You can set a timeout for the length of time the illumination remains on and attempting to decode bar codes when using Character Activation Mode. Set the length (in milliseconds) for a timeout by scanning the following bar code, then setting the timeout (from 1-300,000 milliseconds) by scanning digits from the [Programming Chart](#) inside the back cover of this manual, then scanning **Save**. *Default = 30,000 ms.*



HSTCDT.

Character Activation Timeout

Character Deactivation Mode

If you have sent a character from the host to trigger the scanner to begin scanning, you can also send a deactivation character to stop scanning. Scan the following **On** bar code to use character deactivation, then use Deactivation Character (following) to select the character you will send from the host to terminate scanning. *Default = Off.*



HSTDEN0.

* Off



HSTDEN1.

On

Deactivation Character

This sets the character used to terminate scanning when using Character Deactivation Mode. On the [ASCII Conversion Chart \(Code Page 1252\)](#), page A-3, find the hex value that represents the character you want to use to terminate scanning. Scan the following bar code, then use the [Programming Chart](#) inside the back cover of this manual to read the alphanumeric combination that represents that ASCII character. Scan **Save** to finish. *Default = 14 [DC4].*



HSTDCH.

Deactivation Character

Serial Trigger Mode

You can activate the scan engine either by pressing the trigger, or using a serial trigger command (see [Trigger Commands](#) on page 9-3). When in serial mode, the scan engine scans until a bar code has been read or until the deactivate command is sent. The scan engine can also be set to turn itself off after a specified time has elapsed (see [Read Time-Out](#), which follows).

Read Time-Out

Use this selection to set a time-out (in milliseconds) of the scan engine's trigger when using serial commands to trigger the scan engine. Once the scan engine has timed out, you can activate the scan engine either by pressing the trigger or using a serial trigger command. After scanning the **Read Time-Out** bar code, set the time-out duration (from 0-300,000 milliseconds) by scanning digits on the [Programming Chart](#) inside the back cover, then scanning **Save**. *Default = 30,000 ms.*



TRGSTO.

Read Time-Out

Presentation Mode

Presentation Mode uses ambient light to detect bar codes. The LED dims until a bar code is presented to the scanner, then the LED brightens to read the code. If the light level in the room is not high enough, Presentation Mode may not work properly.

Scan the following bar code to program your scanner for Presentation Mode.

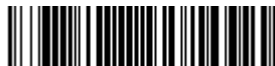

PAPPST.

Presentation Mode

Idle Illumination - Presentation Mode

Scan one of the bar codes below to set the LED illumination for the scanner when it is in an idle state in Presentation Mode. *Default = High.*

Note: If you use one of the lower Idle Illumination settings, and there is not enough ambient light, the scanner may have difficulty detecting when a bar code is presented to it. If the scanner has difficulty “waking up” to read bar codes, you may need to set the Idle Illumination to a brighter setting.



Note: LED Illumination - Presentation Mode does not apply to [Poor Quality PDF Codes](#) or [Mobile Phone Read Mode](#).

Presentation Sensitivity

Presentation Sensitivity is a numeric range that increases or decreases the scan engine's reaction time to bar code presentation. To set the sensitivity, scan the **Sensitivity** bar code, then scan the degree of sensitivity (from 0-20) from the inside back cover, and **Save**. 0 is the most sensitive setting, and 20 is the least sensitive. *Default = 1.*



Presentation Centering

Use Presentation Centering to narrow the scanner's field of view when it is in the stand to make sure the scanner reads only those bar codes intended by the user. For instance, if multiple codes are placed closely together, Presentation Centering will insure that only the desired codes are read.

Note: To adjust centering when the scanner is hand-held, see [Centering](#) (page 3-15).

If a bar code is not touched by a predefined window, it will not be decoded or output by the scanner. If Presentation Centering is turned on by scanning **Presentation Centering On**, the scanner only reads codes that pass through the centering window you specify using the **Top of Presentation Centering Window**, **Bottom of Presentation Centering Window**, **Left**, and **Right of Presentation Centering Window** bar codes.

In the example below, the white box is the centering window. The centering window has been set to 20% left, 30% right, 8% top, and 25% bottom. Since Bar Code 1 passes through the centering window, it will be read. Bar Code 2 does not pass through the centering window, so it will not be read.

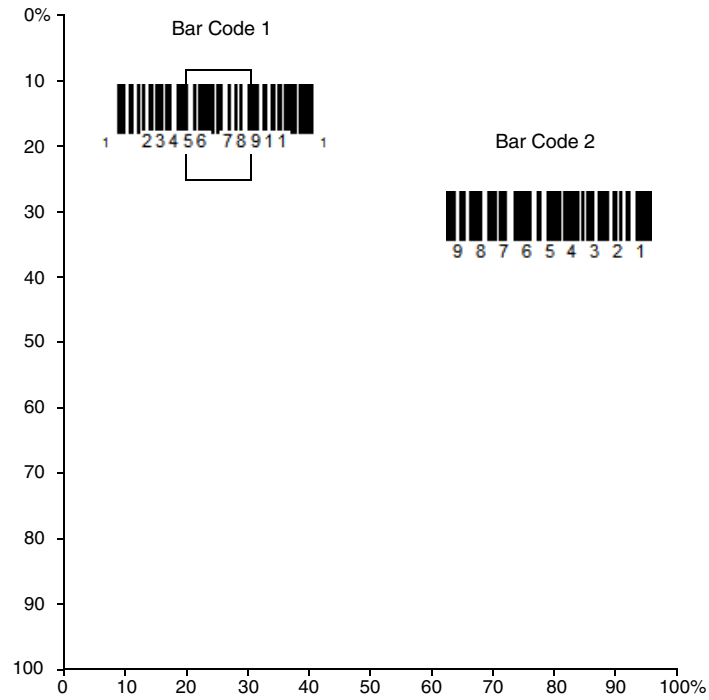

Note: A bar code needs only to be touched by the centering window in order to be read. It does not need to pass completely through the centering window.

Scan **Presentation Centering On**, then scan one of the following bar codes to change the top, bottom, left, or right of the centering window. Then scan the percent you want to shift the centering window using digits on the inside back cover of this manual. Scan **Save**. *Default Presentation Centering = 40% for Top and Left, 60% for Bottom and Right.*



PDCWIN1.
Presentation Centering On



PDCWIND.
*** Presentation Centering Off**



PDCTOP.
Top of Presentation Centering Window



PDCBOT.
Bottom of Presentation Centering Window



PDCLFT.
Left of Presentation Centering Window



PDCRGT.
Right of Presentation Centering Window

*Note: If you are taking images (see [Imaging Commands](#) beginning on page 7-1), you must set the In-Stand Sensor to **Off**.*

You may program a Streaming Presentation Mode (Normal, Enhanced, or Mobile Phone) you wish to use for in-stand scanning, and a Manual Trigger mode (Normal, Enhanced, or Mobile Phone) you wish to use for out-of-stand scanning. To do this, you must first scan the preferred Streaming Presentation mode (see below), then scan the Manual Trigger mode (see [page 3-5](#) and [page 3-11](#)) you want to use.

CodeGate[®]

When CodeGate is **On**, the trigger is used to allow decoded data to be transmitted to the host system. The scanner remains on, scanning and decoding bar codes, but the bar code data is not transmitted until the trigger is pressed. When CodeGate is **Off**, bar code data is transmitted when it is decoded. *Default = CodeGate Off Out-of-Stand.*



AOSCGDD.
*** CodeGate Off Out-of-Stand**



AOSCGD1.
CodeGate On
Out-of-Stand

Mobile Phone Read Mode

When this mode is selected, your scanner is optimized to read bar codes from mobile phone or other LED displays. However, the speed of scanning printed bar codes may be slightly lower when this mode is enabled.



PAPHHC.

Hand Held Scanning - Mobile
Phone



PAPPSC.

Presentation Scanning -
Mobile Phone

Note: To turn off Mobile Phone Read Mode, scan a Manual or Serial Trigger Mode bar code (see page 3-5).

Poor Quality Codes

Poor Quality 1D Codes

This setting improves the scanner's ability to read damaged or badly printed linear bar codes. When **Poor Quality 1D Reading On** is scanned, poor quality linear bar code reading is improved, but the scanner's snappiness is decreased, making it less aggressive when reading good quality bar codes. This setting does not affect 2D bar code reading. *Default = Poor Quality 1D Reading Off.*



DECLD1.

Poor Quality 1D Reading On



DECLD0.

* Poor Quality 1D Reading Off

Poor Quality PDF Codes

This setting improves the scanner's ability to read damaged or badly printed PDF codes by combining information from multiple images. When **Poor Quality PDF On** is scanned, poor quality PDF code reading is improved, but the scanner's snappiness is decreased, making it less aggressive when reading good quality bar codes. This setting does not affect 1D bar code reading. *Default = Poor Quality PDF Reading Off.*



PDFXPR1.

Poor Quality PDF Reading On



PDFXPR0.

* Poor Quality PDF Reading Off

Hands Free Time-Out

The Scan Stand and Presentation Modes are referred to as “hands free” modes. If the scanner’s trigger is pulled when using a hands free mode, the scanner changes to manual trigger mode. You can set the time the scanner should remain in manual trigger mode by setting the Hands Free Time-Out. Once the time-out value is reached, (if there have been no further trigger pulls) the scanner reverts to the original hands free mode.

Scan the **Hands Free Time-Out** bar code, then scan the time-out duration (from 0-300,000 milliseconds) from the inside back cover, and **Save**. *Default = 5,000 ms.*



TRGPTO.

Hands Free Time-Out

Reread Delay

This sets the time period before the scan engine can read the *same* bar code a second time. Setting a reread delay protects against accidental rereads of the same bar code. Longer delays are effective in minimizing accidental rereads. Use shorter delays in applications where repetitive bar code scanning is required. Reread Delay only works when in a [Presentation Mode](#) (see page 3-7). *Default = Medium.*



DLYRRD500.

Short (500 ms)



DLYRRD750.

* Medium (750 ms)



DLYRRD1000.

Long (1000 ms)



DLYRRD2000.

Extra Long (2000 ms)

User-Specified Reread Delay

If you want to set your own length for the reread delay, scan the bar code below, then set the delay (from 0-30,000 milliseconds) by scanning digits from the inside back cover, then scanning **Save**.



DLYRRD.

User-Specified Reread Delay

2D Reread Delay

Sometimes 2D bar codes can take longer to read than other bar codes. If you wish to set a separate Reread Delay for 2D bar codes, scan one of the programming codes that follows. **2D Reread Delay Off** indicates that the time set for [Reread Delay](#) is used for both 1D and 2D bar codes. *Default = 2D Reread Delay Off.*



DLY2RR0.

* 2D Reread Delay Off



DLY2RR1000.

Short (1000ms)



DLY2RR2000.

Medium (2000ms)



DLY2RR3000.

Long (3000ms)



DLY2RR4000.

Extra Long (4000ms)

Illumination Lights

If you want the illumination lights on while reading a bar code, scan the **Lights On** bar code, below. However, if you want to turn just the lights off, scan the **Lights Off** bar code. *Default = Lights On.*

Note: This setting does not affect the aimer light. The aiming light can be set using [Aimer Mode](#) (page 3-14).



SCNLED1.

* Lights On



SCNLED0.

Lights Off

Aimer Delay

The aimer delay allows a delay time for the operator to aim the scan engine before the picture is taken. Use these codes to set the time between when the trigger is pulled and when the picture is taken. During the delay time, the aiming light will appear, but the LEDs won't turn on until the delay time is over. *Default = Off.*



User-Specified Aimer Delay

If you want to set your own length for the duration of the delay, scan the bar code below, then set the time-out by scanning digits (0 - 4,000 ms) from the [Programming Chart](#) inside the back cover of this manual, then scan **Save**.



Aimer Mode

This feature allows you to turn the aimer on and off. When turning the aimer on, there are 2 options: Interlaced (the aimer is interlaced with the illumination LEDs) and Interlace Optimized for Decode (same as Interlaced except the aimer flashes so that it is not captured in the image). *Default = Interlaced.*

Note: If you are having a hard time decoding using Interlaced, use Interlaced Optimized for Decode.



Centering

Use Centering to narrow the scan engine's field of view to make sure that when the scanner is hand-held, it reads only those bar codes intended by the user. For instance, if multiple codes are placed closely together, centering will insure that only the desired codes are read. (Centering can be used in conjunction with [Aimer Delay](#), page 3-14, for the most error-free operation in applications where multiple codes are spaced closely together. Using the Aimer Delay and Centering features, the scanner can emulate the operation of older systems, such as linear laser bar code scanners.)

If a bar code is not touched by a predefined window, it will not be decoded or output by the scan engine. If centering is turned on by scanning **Centering On**, the scan engine only reads codes that pass through the centering window you specify using the **Top of Centering Window** and **Bottom of Centering Window** bar codes.

In the example below, the white box is the centering window. The centering window has been set to 8% top and 25% bottom. Since Bar Code 1 passes through the centering window, it will be read. Bar Code 2 does not pass through the centering window, so it will not be read.

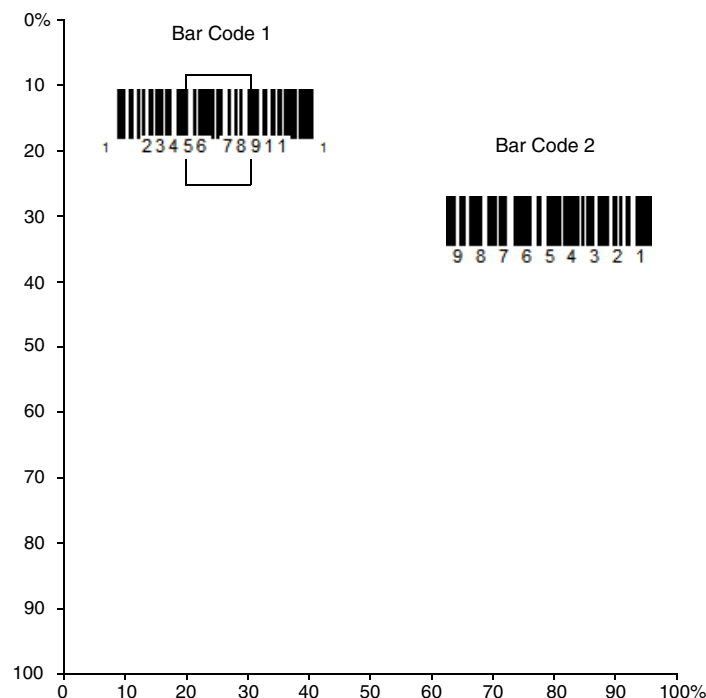

A bar code needs only to be touched by the centering window in order to be read. It does not need to pass completely through the centering window.

Scan **Centering On**, then scan one of the following bar codes to change the top and bottom of the centering window. Then scan the percent you want to shift the centering window using digits on the inside back cover of this manual. Scan **Save**. *Default Centering = 40% for Top, 60% for Bottom.*



DECWIN1.
Centering On



DECWIND.
* Centering Off



DECTOP.
Top of Centering Window



DECBOT.
Bottom of Centering Window

Output Sequence Overview

Output Sequence Editor

This programming selection allows you to program the scan engine to output data (when scanning more than one symbol) in whatever order your application requires, regardless of the order in which the bar codes are scanned. Reading the **Default Sequence** symbol programs the scan engine to the Universal values, shown below. These are the defaults. Be **certain** you want to delete or clear all formats before you read the **Default Sequence** symbol.

Note: To make Output Sequence Editor selections, you'll need to know the code I.D., code length, and character match(es) your application requires. Use the Alphanumeric symbols (inside back cover) to read these options. You must hold the trigger while reading each bar code in the sequence.

To Add an Output Sequence

1. Scan the **Enter Sequence** symbol (see [Require Output Sequence](#), page 3-18).
2. **Code I.D.**
On the [Symbology Charts](#) on page A-1, find the symbology to which you want to apply the output sequence format. Locate the Hex value for that symbology and scan the 2 digit hex value from the Programming Chart (inside back cover).
3. **Length**
Specify what length (up to 9999 characters) of data output will be acceptable for this symbology. Scan the four digit data length from the Programming Chart. (Note: 50 characters is entered as 0050. 9999 is a universal number, indicating all lengths.) When calculating the length, you must count any programmed prefixes, suffixes, or formatted characters as part of the length (unless using 9999).
4. **Character Match Sequences**
On the [ASCII Conversion Chart \(Code Page 1252\)](#), page A-3, find the Hex value that represents the character(s) you want to match. Use the Programming Chart to read the alphanumeric combination that represents the ASCII characters. (99 is the Universal number, indicating all characters.)
5. **End Output Sequence Editor**
Scan **FF** to enter an Output Sequence for an additional symbology, or **Save** to save your entries.

Other Programming Selections

- **Discard**
This exits without saving any Output Sequence changes.

Output Sequence Example

In this example, you are scanning Code 93, Code 128, and Code 39 bar codes, but you want the scanner to output Code 39 1st, Code 128 2nd, and Code 93 3rd, as shown below.

Note: Code 93 must be enabled to use this example.



A - Code 39



B - Code 128



C - Code 93

You would set up the sequence editor with the following command line:

```
SEQBLK62999941FF6A999942FF69999943FF
```

The breakdown of the command line is shown below:

SEQBLKsequence editor start command

62 code identifier for **Code 39**
9999 code length that must match for Code 39, 9999 = all lengths
41 start character match for Code 39, 41h = "A"
FF termination string for first code
6A code identifier for **Code 128**
9999 code length that must match for Code 128, 9999 = all lengths
42 start character match for Code 128, 42h = "B"
FF termination string for second code
69 code identifier for **Code 93**
9999 code length that must match for Code 93, 9999 = all lengths
43 start character match for Code 93, 43h = "C"
FF termination string for third code

To program the previous example using specific lengths, you would have to count any programmed prefixes, suffixes, or formatted characters as part of the length. If you use the example on [page 3-17](#), but assume a <CR> suffix and specific code lengths, you would use the following command line:

```
SEQBLK62001241FF6A001342FF69001243FF
```

The breakdown of the command line is shown below:

SEQBLKsequence editor start command

62 code identifier for **Code 39**
0012 A - Code 39 sample length (11) plus CR suffix (1) = 12
41 start character match for Code 39, 41h = "A"
FF termination string for first code
6A code identifier for **Code 128**
0013 B - Code 128 sample length (12) plus CR suffix (1) = 13
42 start character match for Code 128, 42h = "B"
FF termination string for second code
69 code identifier for **Code 93**
0012 C - Code 93 sample length (11) plus CR suffix (1) = 12
43 start character match for Code 93, 43h = "C"

FF termination string for third code

Output Sequence Editor



Partial Sequence

If an output sequence operation is terminated before all your output sequence criteria are met, the bar code data acquired to that point is a "partial sequence."

Scan **Discard Partial Sequence** to discard partial sequences when the output sequence operation is terminated before completion. Scan **Transmit Partial Sequence** to transmit partial sequences. (Any fields in the sequence where no data match occurred will be skipped in the output.)



Require Output Sequence

When an output sequence is **Required**, all output data must conform to an edited sequence or the scan engine will not transmit the output data to the host device. When it's **On/Not Required**, the scan engine will attempt to get the output data to conform to an edited sequence but, if it cannot, the scan engine transmits all output data to the host device as is.

When the output sequence is **Off**, the bar code data is output to the host as the scan engine decodes it. *Default = Off.*

Note: This selection is unavailable when the Multiple Symbols Selection is turned on.



Multiple Symbols

When this programming selection is turned **On**, it allows you to read multiple symbols with a single pull of the scanner's trigger. If you press and hold the trigger, aiming the scanner at a series of symbols, it reads unique symbols once, beeping (if turned on) for each read. The scanner attempts to find and decode new symbols as long as the trigger is pulled. When this programming selection is turned **Off**, the scanner will only read the symbol closest to the aiming beam. *Default = Off.*



No Read

With No Read turned **On**, the scan engine notifies you if a code cannot be read. If using an EZConfig-Scanning Tool Scan Data Window (see page 8-2), an "NR" appears when a code cannot be read. If No Read is turned **Off**, the "NR" will not appear. *Default = Off.*



If you want a different notation than "NR," for example, "Error," or "Bad Code," you can edit the output message (see [Data Formatting](#) beginning on page 5-1). The hex code for the No Read symbol is 9C.

Video Reverse

Video Reverse is used to allow the scan engine to read bar codes that are inverted. The **Video Reverse Off** bar code below is an example of this type of bar code. Scan **Video Reverse Only** to read *only* inverted bar codes. Scan **Video Reverse and Standard Bar Codes** to read both types of codes.

*Note: After scanning **Video Reverse Only**, menu bar codes cannot be read. You must scan **Video Reverse Off** or **Video Reverse and Standard Bar Codes** in order to read menu bar codes.*

Note: Images downloaded from the unit are not reversed. This is a setting for decoding only.





* Video Reverse Off

Working Orientation

Some bar codes are direction-sensitive. For example, KIX codes can misread when scanned sideways or upside down. Use the working orientation settings if your direction-sensitive codes will not usually be presented upright to the scanner. *Default = Upright.*

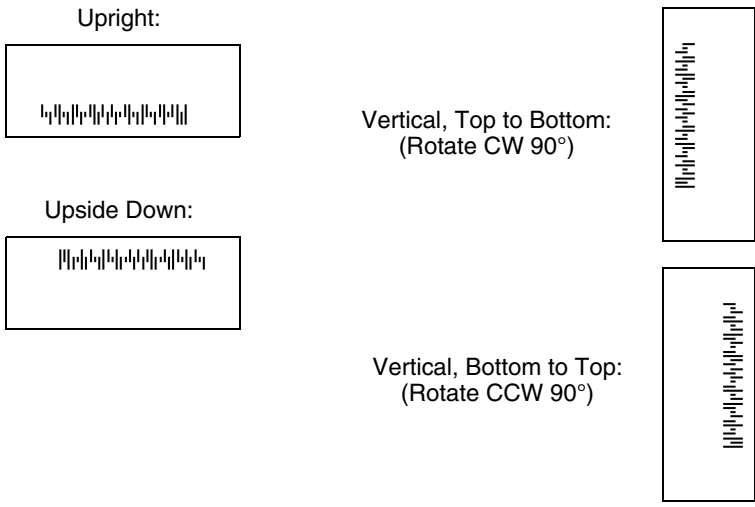

Prefix/Suffix Overview

When a bar code is scanned, additional information is sent to the host computer along with the bar code data. This group of bar code data and additional, user-defined data is called a “message string.” The selections in this section are used to build the user-defined data into the message string.

Prefix and Suffix characters are data characters that can be sent before and after scanned data. You can specify if they should be sent with all symbologies, or only with specific symbologies. The following illustration shows the breakdown of a message string:

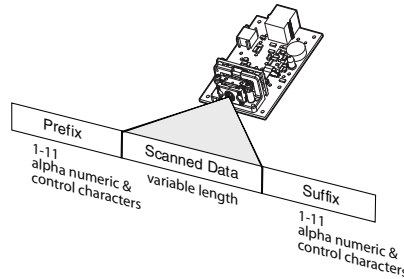

Points to Keep In Mind

- It is not necessary to build a message string. The selections in this chapter are only used if you wish to alter the default settings. *Default prefix = None. Default suffix = None.*
- A prefix or suffix may be added or cleared from one symbology or all symbologies.
- You can add any prefix or suffix from the [ASCII Conversion Chart \(Code Page 1252\)](#), beginning on page A-3, plus Code I.D. and AIM I.D.
- You can string together several entries for several symbologies at one time.
- Enter prefixes and suffixes in the order in which you want them to appear on the output.
- When setting up for specific symbologies (as opposed to all symbologies), the specific symbology ID value counts as an added prefix or suffix character.
- The maximum size of a prefix or suffix configuration is 200 characters, which includes header information.

To Add a Prefix or Suffix:

Step 1. Scan the **Add Prefix** or **Add Suffix** symbol ([page 4-2](#)).

Step 2. Determine the 2 digit Hex value from the Symbology Chart (included in the [Symbology Charts](#), beginning on page A-1) for the symbology to which you want to apply the prefix or suffix. For example, for Code 128, Code ID is “j” and Hex ID is “6A”.

Step 3. Scan the 2 hex digits from the [Programming Chart](#) inside the back cover of this manual or scan **9, 9** for all symbologies.

Step 4. Determine the hex value from the [ASCII Conversion Chart \(Code Page 1252\)](#), beginning on page A-3, for the prefix or suffix you wish to enter.

Note: To add the Code I.D., scan **5, C, 8, 0**.

To add AIM I.D., scan **5, C, 8, 1**.

To add a backslash (\), scan **5, C, 5, C**.

To add a backslash (\) as in Step 7, you must scan 5C twice – once to create the leading backslash and then to create the backslash itself.

Step 5. Scan the 2 digit hex value from the [Programming Chart](#) inside the back cover of this manual.

Step 6. Repeat Steps 4 and 5 for every prefix or suffix character.

Step 7. Scan **Save** to exit and save, or scan **Discard** to exit without saving.

Repeat Steps 1-6 to add a prefix or suffix for another symbology.

Example: Add a Tab Suffix to All Symbologies

Step 1. Scan **Add Suffix**.

Step 2. Scan **9, 9** from the [Programming Chart](#) inside the back cover of this manual to apply this suffix to all symbologies.

Step 3. Scan **0, 9** from the [Programming Chart](#) inside the back cover of this manual. This corresponds with the hex value for a horizontal tab, shown in the [ASCII Conversion Chart \(Code Page 1252\)](#), beginning on page A-3.

Scan **Save**, or scan **Discard** to exit without saving.

To Clear One or All Prefixes or Suffixes

You can clear a single prefix or suffix, or clear all prefixes/suffixes for a symbology. If you have been entering prefixes and suffixes for single symbologies, you can use **Clear One Prefix (Suffix)** to delete a specific character from a symbology. When you **Clear All Prefixes (Suffixes)**, all the prefixes or suffixes for a symbology are deleted.

Step 1. Scan the **Clear One Prefix** or **Clear One Suffix** symbol.

Step 2. Determine the 2 digit Hex value from the Symbology Chart (included in the [Symbology Charts](#), beginning on page A-1) for the symbology from which you want to clear the prefix or suffix.

Step 3. Scan the 2 digit hex value from the [Programming Chart](#) inside the back cover of this manual or scan **9, 9** for all symbologies.

Your change is automatically saved.

To Add a Carriage Return Suffix to All Symbologies

Scan the following bar code if you wish to add a carriage return suffix to all symbologies at once. This action first clears all current suffixes, then programs a carriage return suffix for all symbologies.



Prefix Selections



Suffix Selections





Function Code Transmit

When this selection is enabled and function codes are contained within the scanned data, the scan engine transmits the function code to the terminal. Charts of these function codes are provided in [ASCII Conversion Chart \(Code Page 1252\)](#) starting on [page A-3](#). When the scanner is in keyboard wedge mode, the scan code is converted to a key code before it is transmitted.

Default = Enable.



Intercharacter, Interfunction, and Intermassage Delays

Some terminals drop information (characters) if data comes through too quickly. Intercharacter, interfunction, and intermessage delays slow the transmission of data, increasing data integrity.

Intercharacter Delay

An intercharacter delay of up to 5000 milliseconds (in 5ms increments) may be placed between the transmission of each character of scanned data. Scan the **Intercharacter Delay** bar code below, then scan the number of 5ms delays, and the **Save** bar code using the [Programming Chart](#) inside the back cover of this manual.

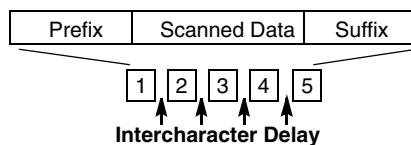

To remove this delay, scan the **Intercharacter Delay** bar code, then set the number of delays to 0. Scan the **Save** bar code using the [Programming Chart](#) inside the back cover of this manual.

Note: Intercharacter delays are not supported in USB serial emulation.

User Specified Intercharacter Delay

An intercharacter delay of up to 5000 milliseconds (in 5ms increments) may be placed after the transmission of a particular character of scanned data. Scan the **Delay Length** bar code below, then scan the number of 5ms delays, and the **Save** bar code using the [Programming Chart](#) inside the back cover of this manual.

Next, scan the **Character to Trigger Delay** bar code, then the 2-digit hex value for the ASCII character that will trigger the delay [ASCII Conversion Chart \(Code Page 1252\)](#), beginning on page A-3.

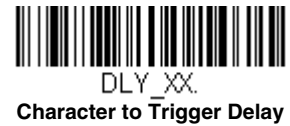

To remove this delay, scan the **Delay Length** bar code, and set the number of delays to 0. Scan the **Save** bar code using the [Programming Chart](#) inside the back cover of this manual.

Interfunction Delay

An interfunction delay of up to 5000 milliseconds (in 5ms increments) may be placed between the transmission of each control character in the message string. Scan the **Interfunction Delay** bar code below, then scan the number of 5ms delays, and the **Save** bar code using the [Programming Chart](#) inside the back cover of this manual.

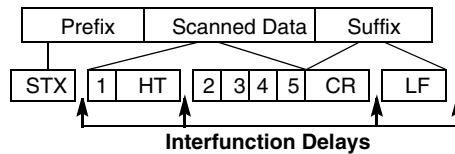

To remove this delay, scan the **Interfunction Delay** bar code, then set the number of delays to 0. Scan the **Save** bar code using the [Programming Chart](#) inside the back cover of this manual.

Intermessage Delay

An intermessage delay of up to 5000 milliseconds (in 5ms increments) may be placed between each scan transmission. Scan the **Intermessage Delay** bar code below, then scan the number of 5ms delays, and the **Save** bar code using the [Programming Chart](#) inside the back cover of this manual.

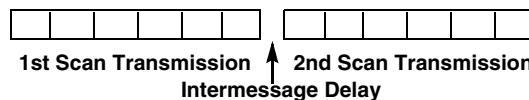

To remove this delay, scan the **Intermessage Delay** bar code, then set the number of delays to 0. Scan the **Save** bar code using the [Programming Chart](#) inside the back cover of this manual.

Data Formatting

Data Format Editor Introduction

You may use the Data Format Editor to change the scan engine's output. For example, you can use the Data Format Editor to insert characters at certain points in bar code data as it is scanned. The selections in the following pages are used only if you wish to alter the output. *Default Data Format setting = None.*

Normally, when you scan a bar code, it is output automatically. However, when you create a format, you must use a "send" command (see [Send Commands](#) on page 5-3) within the format program to output data.

Multiple formats may be programmed into the scan engine. They are stacked in the order in which they are entered. However, the following list presents the order in which formats are applied:

1. Specific Terminal ID, Actual Code ID, Actual Length
2. Specific Terminal ID, Actual Code ID, Universal Length
3. Specific Terminal ID, Universal Code ID, Actual Length
4. Specific Terminal ID, Universal Code ID, Universal Length
5. Universal Terminal ID, Actual Code ID, Actual Length
6. Universal Terminal ID, Actual Code ID, Universal Length
7. Universal Terminal ID, Universal Code ID, Actual Length
8. Universal Terminal ID, Universal Code ID, Universal Length

The maximum size of a data format configuration is 2000 bytes, which includes header information.

If a bar code is read that fails the first data format, the next data format, if there is one, will be used on the bar code data. If there is no other data format, the raw data is output.

If you have changed data format settings, and wish to clear all formats and return to the factory defaults, scan the **Default Data Format** code below.



Add a Data Format

Step 1. Scan the **Enter Data Format** symbol ([page 5-2](#)).

Step 2. Select **Primary/Alternate Format**

Determine if this will be your primary data format, or one of 3 alternate formats. This allows you to save a total of 4 different data formats. To program your primary format, scan **0** using the [Programming Chart](#) inside the back cover of this manual. If you are programming an alternate format, scan **1**, **2**, or **3**, depending on which alternate format you are programming. (See "Primary/Alternate Data Formats" on page 5-10 for further information.)

Step 3. Terminal Type

Refer to [Terminal ID Table](#) (page 5-3) and locate the Terminal ID number for your PC. Scan three numeric bar codes on the inside back cover to program the scan engine for your terminal ID (you must enter 3 digits). For example, scan **0 0 3** for an AT wedge.

Note: 099 indicates all terminal types.

Step 4. Code I.D.

In the [Symbology Charts](#), beginning on page A-1, find the symbology to which you want to apply the data format. Locate the Hex value for that symbology and scan the 2 digit hex value from the [Programming Chart](#) inside the back cover of this manual.

If you are creating a data format for Batch Mode Quantity, use 35 for the Code I.D.

Note: 99 indicates all symbologies.

Step 5. Length

Specify what length (up to 9999 characters) of data will be acceptable for this symbology. Scan the four digit data length from the [Programming Chart](#) inside the back cover of this manual. For example, 50 characters is entered as 0050.

Note: 9999 indicates all lengths.

Step 6. Editor Commands

Refer to [Data Format Editor Commands](#) (page 5-3). Scan the symbols that represent the command you want to enter.

Step 7. Scan **Save** to save your data format, or **Discard** to exit without saving your changes.



DFMBK3.

Enter Data Format



MNUSAV.

Save



MNUABT.

Discard

Other Programming Selections

Clear One Data Format

This deletes one data format for one symbology. If you are clearing the primary format, scan **0** from the [Programming Chart](#) inside the back cover of this manual. If you are clearing an alternate format, scan **1**, **2**, or **3**, depending on the format you are clearing. Scan the Terminal Type and Code I.D. (see [Symbology Charts](#) on page A-1), and the bar code data length for the specific data format that you want to delete. All other formats remain unaffected.

Clear all Data Formats

This clears all data formats.

Save to exit and save your data format changes.

Discard to exit without saving any data format changes.



DFMCL3.

Clear One Data Format



DFMCA3.

Clear All Data Formats



MNUSAV.

Save



MNUABT.

Discard

Terminal ID Table

Terminal	Model(s)	Terminal ID
USB	PC keyboard (HID)	124
	Mac Keyboard	125
	PC Keyboard (Japanese)	134
	Serial (COM driver required)	130
	HID POS	131
	USB SurePOS Handheld	128
	USB SurePOS Tabletop	129
Serial	RS232 TTL	000
	RS232 True	000
	RS485 (IBM-HHBCR 1+2, 46xx)	051
Keyboard	PS2 compatibles	003
	AT compatibles	002

Data Format Editor Commands

When working with the Data Format Editor, a virtual cursor is moved along your input data string. The following commands are used to both move this cursor to different positions, and to select, replace, and insert data into the final output.

Send Commands

Send all characters

- F1 Include in the output message all of the characters from the input message, starting from current cursor position, followed by an insert character. *Syntax = F1xx* where xx stands for the insert character's hex value for its ASCII code. Refer to the [ASCII Conversion Chart \(Code Page 1252\)](#), beginning on page A-3 for decimal, hex and character codes.

Send a number of characters

- F2 Include in the output message a number of characters followed by an insert character. Start from the current cursor position and continue for "nn" characters or through the last character in the input message, followed by character "xx." *Syntax = F2nxx* where nn stands for the numeric value (00-99) for the number of characters, and xx stands for the insert character's hex value for its ASCII code. Refer to the [ASCII Conversion Chart \(Code Page 1252\)](#), beginning on page A-3 for decimal, hex and character codes.

F2 Example: Send a number of characters



Send the first 10 characters from the bar code above, followed by a carriage return. Command string: **F2100D**

F2 is the "Send a number of characters" command

10 is the number of characters to send

0D is the hex value for a CR

The data is output as: **1234567890**

F2 and F1 Example: Split characters into 2 lines

Send the first 10 characters from the bar code above, followed by a carriage return, followed by the rest of the characters.

Command string: **F2100DF10D**

F2 is the "Send a number of characters" command

10 is the number of characters to send for the first line

0D is the hex value for a CR

F1 is the "Send all characters" command

0D is the hex value for a CR

The data is output as:

1234567890
ABCDEFGHIJ
<CR>

Send all characters up to a particular character

- F3 Include in the output message all characters from the input message, starting with the character at the current cursor position and continuing to, but not including, the search character "ss," followed by an insert character. The cursor is moved forward to the "ss" character. *Syntax = F3ssxx* where ss stands for the search character's hex value for its ASCII code, and xx stands for the insert character's hex value for its ASCII code. Refer to the [ASCII Conversion Chart \(Code Page 1252\)](#), beginning on page A-3 for decimal, hex and character codes.

F3 Example: Send all characters up to a particular character



Using the bar code above, send all characters up to but not including "D," followed by a carriage return.

Command string: **F3440D**

F3 is the "Send all characters up to a particular character" command

44 is the hex value for a 'D'

0D is the hex value for a CR

The data is output as:

1234567890ABC
<CR>

Send all but the last characters

- E9 Include in the output message all but the last "nn" characters, starting from the current cursor position. The cursor is moved forward to one position past the last input message character included. *Syntax = E9nn* where nn stands for the numeric value (00-99) for the number of characters that will not be sent at the end of the message.

Insert a character multiple times

- F4 Send "xx" character "nn" times in the output message, leaving the cursor in the current position. *Syntax = F4xxnn* where xx stands for the insert character's hex value for its ASCII code, and nn is the numeric value (00-99) for the number of times it should be sent. Refer to the [ASCII Conversion Chart \(Code Page 1252\)](#), beginning on page A-3 for decimal, hex and character codes.

E9 and F4 Example: Send all but the last characters, followed by 2 tabs



Send all characters except for the last 8 from the bar code above, followed by 2 tabs.

Command string: **E908F40902**

E9 is the "Send all but the last characters" command

08 is the number of characters at the end to ignore

F4 is the "Insert a character multiple times" command

09 is the hex value for a horizontal tab

02 is the number of times the tab character is sent

The data is output as: **1234567890AB <tab><tab>**

Move Commands

Move the cursor forward a number of characters

- F5 Move the cursor ahead “nn” characters from current cursor position.
Syntax = F5nn where nn is the numeric value (00-99) for the number of characters the cursor should be moved ahead.

F5 Example: Move the cursor forward and send the data



Move the cursor forward 3 characters, then send the rest of the bar code data from the bar code above. End with a carriage return.

Command string: **F503F10D**

F5 is the “Move the cursor forward a number of characters” command

03 is the number of characters to move the cursor

F1 is the “Send all characters” command

0D is the hex value for a CR

The data is output as:

4567890ABCDEFGHIJ

<CR>

Move the cursor backward a number of characters

- F6 Move the cursor back “nn” characters from current cursor position.
Syntax = F6nn where nn is the numeric value (00-99) for the number of characters the cursor should be moved back.

Move the cursor to the beginning

- F7 Move the cursor to the first character in the input message. *Syntax = F7.*

FE and F7 Example: Manipulate bar codes that begin with a 1



Search for bar codes that begin with a 1. If a bar code matches, move the cursor back to the beginning of the data and send 6 characters followed by a carriage return. Using the bar code above:

Command string: **FE31F7F2060D**

FE is the “Compare characters” command

31 is the hex value for 1

F7 is the “Move the cursor to the beginning” command

F2 is the “Send a number of characters” command

06 is the number of characters to send

0D is the hex value for a CR

The data is output as:

123456

<CR>

Move the cursor to the end

- EA Move the cursor to the last character in the input message. *Syntax = EA.*

Search Commands

Search forward for a character

- F8 Search the input message forward for “xx” character from the current cursor position, leaving the cursor pointing to the “xx” character. *Syntax = F8xx* where xx stands for the search character’s hex value for its ASCII code. Refer to the [ASCII Conversion Chart \(Code Page 1252\)](#), beginning on page A-3 for decimal, hex and character codes.

F8 Example: Send bar code data that starts after a particular character



Search for the letter “D” in bar codes and send all the data that follows, including the “D.” Using the bar code above:

Command string: **F844F10D**

F8 is the “Search forward for a character” command

44 is the hex value for “D”

F1 is the “Send all characters” command

0D is the hex value for a CR

The data is output as:

DEFGHIJ

<CR>

Search backward for a character

- F9 Search the input message backward for “xx” character from the current cursor position, leaving the cursor pointing to the “xx” character. *Syntax = F9xx* where xx stands for the search character’s hex value for its ASCII code. Refer to the [ASCII Conversion Chart \(Code Page 1252\)](#), beginning on page A-3 for decimal, hex and character codes.

Search forward for a non-matching character

- E6 Search the input message forward for the first non-“xx” character from the current cursor position, leaving the cursor pointing to the non-“xx” character. *Syntax = E6xx* where xx stands for the search character’s hex value for its ASCII code. Refer to the [ASCII Conversion Chart \(Code Page 1252\)](#), beginning on page A-3 for decimal, hex and character codes.

E6 Example: Remove zeroes at the beginning of bar code data



This example shows a bar code that has been zero filled. You may want to ignore the zeroes and send all the data that follows. E6 searches forward for the first character that is not zero, then sends all the data after, followed by a carriage return. Using the bar code above:

Command string: **E630F10D**

E6 is the “Search forward for a non-matching character” command

30 is the hex value for 0

F1 is the “Send all characters” command

0D is the hex value for a CR

The data is output as:

37692

<CR>

Search backward for a non-matching character

- E7 Search the input message backward for the first non-“xx” character from the current cursor position, leaving the cursor pointing to the non-“xx” character. *Syntax = E7xx* where xx stands for the search character’s hex value for its ASCII code. Refer to the [ASCII Conversion Chart \(Code Page 1252\)](#), beginning on page A-3 for decimal, hex and character codes.

Miscellaneous Commands

Suppress characters

- FB Suppress all occurrences of up to 15 different characters, starting at the current cursor position, as the cursor is advanced by other commands. When the FC command is encountered, the suppress function is terminated. The cursor is not moved by the FB command.
Syntax = FBnnxxyy . .zz where nn is a count of the number of suppressed characters in the list, and xxyy .. zz is the list of characters to be suppressed.

FB Example: Remove spaces in bar code data



This example shows a bar code that has spaces in the data. You may want to remove the spaces before sending the data. Using the bar code above:

Command string: **FB0120F10D**

FB is the "Suppress characters" command

01 is the number of character types to be suppressed

20 is the hex value for a space

F1 is the "Send all characters" command

0D is the hex value for a CR

The data is output as:

34567890

<CR>

Stop suppressing characters

- FC Disables suppress filter and clear all suppressed characters. *Syntax = FC.*

Replace characters

- E4 Replaces up to 15 characters in the output message, without moving the cursor. Replacement continues until the E5 command is encountered. *Syntax = E4nnxx₁xx₂yy₁yy₂...zz₁zz₂* where nn is the total count of the number of characters in the list (characters to be replaced plus replacement characters); xx₁ defines characters to be replaced and xx₂ defines replacement characters, continuing through zz₁ and zz₂.

E4 Example: Replace zeroes with CRs in bar code data



If the bar code has characters that the host application does not want included, you can use the E4 command to replace those characters with something else. In this example, you will replace the zeroes in the bar code above with carriage returns.

Command string: **E402300DF10D**

E4 is the "Replace characters" command

02 is the total count of characters to be replaced, plus the replacement characters (0 is replaced by CR, so total characters = 2)

30 is the hex value for 0

0D is the hex value for a CR (the character that will replace the 0)

F1 is the "Send all characters" command

0D is the hex value for a CR

The data is output as:

1234
5678
ABC
<CR>

Stop replacing characters

E5 Terminates character replacement. *Syntax = E5.*

Compare characters

FE Compare the character in the current cursor position to the character “xx.” If characters are equal, move the cursor forward one position. *Syntax = FExx* where xx stands for the comparison character’s hex value for its ASCII code. Refer to the [ASCII Conversion Chart \(Code Page 1252\)](#), beginning on page A-3 for decimal, hex and character codes.

Check for a number

EC Check to make sure there is an ASCII number at the current cursor position. The format is aborted if the character is not numeric.

EC Example: Only output the data if the bar code begins with a number

If you want only data from bar codes that begin with a number, you can use EC to check for the number.

Command string: **ECF10D**

EC is the “Check for a number” command

F1 is the “Send all characters” command

0D is the hex value for a CR

If this bar code is read,  the next data format, if there is one, will be used on the data. If there is no other format, the format fails and the raw data is output as **AB1234**.

If this bar code is read:  the data is output as:

1234AB
<CR>

Check for non-numeric character

ED Check to make sure there is a non-numeric ASCII character at the current cursor position. The format is aborted if the character is numeric.

ED Example: Only output the data if the bar code begins with a letter

If you want only data from bar codes that begin with a letter, you can use ED to check for the letter.

Command string: **EDF10D**

ED is the “Check for a non-numeric character” command

F1 is the “Send all characters” command

0D is the hex value for a CR

If this bar code is read,  the next data format, if there is one, will be used on this data. If there is no other format, the format fails and the raw data is output as **1234AB**.

If this bar code is read:  the data is output as:

AB1234
<CR>

Insert a delay

EF Inserts a delay of up to 49,995 milliseconds (in multiples of 5), starting from the current cursor position. Syntax = EFnnnn where nnnn stands for the delay in 5ms increments, up to 9999. This command can only be used with keyboard emulation.a

Data Formatter

When Data Formatter is turned Off, the bar code data is output to the host as read, including prefixes and suffixes.



DFM_END.

Data Formatter Off

You may wish to require the data to conform to a data format you have created and saved. The following settings can be applied to your data format:

Data Formatter On, Not Required, Keep Prefix/Suffix

Scanned data is modified according to your data format, and prefixes and suffixes are transmitted.

Data Formatter On, Not Required, Drop Prefix/Suffix

Scanned data is modified according to your data format. If a data format is found for a particular symbol, those prefixes and suffixes are not transmitted. If a data format is *not* found for that symbol, the prefixes and suffixes *are* transmitted.

Data Format Required, Keep Prefix/Suffix

Scanned data is modified according to your data format, and prefixes and suffixes are transmitted. Any data that does not match your data format requirements generates an error tone and the data in that bar code is not transmitted. If you wish to process this type of bar code without generating an error tone, see [Primary/Alternate Data Formats](#).

Data Format Required, Drop Prefix/Suffix

Scanned data is modified according to your data format. If a data format is found for a particular symbol, those prefixes and suffixes are not transmitted. Any data that does not match your data format requirements generates an error tone. If you wish to process this type of bar code without generating an error tone, see [Primary/Alternate Data Formats](#).

Choose one of the following options. *Default = Data Formatter On, Not Required, Keep Prefix/Suffix.*



DFM_EN1.

*** Data Formatter On,
Not Required,
Keep Prefix/Suffix**



DFM_EN3.

**Data Formatter On,
Not Required,
Drop Prefix/Suffix**



DFM_EN2.

**Data Format Required,
Keep Prefix/Suffix**



DFM_EN4.

**Data Format Required,
Drop Prefix/Suffix**

Primary/Alternate Data Formats

You can save up to four data formats, and switch between these formats. Your primary data format is saved under **0**. Your other three formats are saved under **1**, **2**, and **3**. To set your device to use one of these formats, scan one of the bar codes below.



ALTFNM0.

Primary Data Format



ALTFNM1.

Data Format 1



ALTFNM2.

Data Format 2



ALTFNM3.

Data Format 3

Symbologies

This programming section contains the following menu selections. Refer to [Chapter 9](#) for settings and defaults.

- All Symbologies
- Aztec Code
- China Post (Hong Kong 2 of 5)
- Chinese Sensible (Han Xin) Code
- Codabar
- Codablock A
- Codablock F
- Code 11
- Code 128
- Code 32 Pharmaceutical (PARAF)
- Code 39
- Code 93
- Data Matrix
- EAN/JAN-13
- EAN/JAN-8
- GS1 Composite Codes
- GS1 DataBar Expanded
- GS1 DataBar Limited
- GS1 DataBar Omnidirectional
- GS1 Emulation
- GS1-128
- Interleaved 2 of 5
- Korea Post
- Matrix 2 of 5
- MaxiCode
- MicroPDF417
- MSI
- NEC 2 of 5
- Postal Codes - 2D
- Postal Codes - Linear
- PDF417
- GS1 DataBar Omnidirectional
- QR Code
- Straight 2 of 5 IATA (two-bar start/stop)
- Straight 2 of 5 Industrial (three-bar start/stop)
- TCIF Linked Code 39 (TLC39)
- UPC-A
- UPC-A/EAN-13 with Extended Coupon Code
- UPC-E0
- UPC-E1

All Symbologies

If you want to decode all the symbologies allowable for your scanner, scan the **All Symbologies On** code. If on the other hand, you want to decode only a particular symbology, scan **All Symbologies Off** followed by the On symbol for that particular symbology.

Note: Scanner performance may reduce by scanning All Symbologies On. Only scan All Symbologies On when needed.



ALLENA1.
All Symbologies On



ALLENA0.
All Symbologies Off

Note: When All Symbologies On is scanned, 2D Postal Codes are not enabled. 2D Postal Codes must be enabled separately.

Message Length Description

You are able to set the valid reading length of some of the bar code symbologies. You may wish to set the same value for minimum and maximum length to force the scanner to read fixed length bar code data. This helps reduce the chances of a misread.

EXAMPLE: Decode only those bar codes with a count of 9-20 characters.
Min. length = 09Max. length = 20

EXAMPLE: Decode only those bar codes with a count of 15 characters.
Min. length = 15Max. length = 15

For a value other than the minimum and maximum message length defaults, scan the bar codes included in the explanation of the symbology, then scan the digit value of the message length and **Save** bar codes on the [Programming Chart](#) inside the back cover of this manual. The minimum and maximum lengths and the defaults are included with the respective symbologies.

Codabar

<Default All Codabar Settings>



Codabar On/Off



Codabar Start/Stop Characters

Start/Stop characters identify the leading and trailing ends of the bar code. You may either transmit, or not transmit Start/Stop characters. *Default = Don't Transmit.*



Codabar Check Character

Codabar check characters are created using different "modulos." You can program the scanner to read only Codabar bar codes with Modulo 16 check characters. *Default = No Check Character.*

No Check Character indicates that the scanner reads and transmits bar code data with or without a check character.

When Check Character is set to **Validate and Transmit**, the scanner will only read Codabar bar codes printed with a check character, and will transmit this character at the end of the scanned data.

When Check Character is set to **Validate, but Don't Transmit**, the unit will only read Codabar bar codes printed **with** a check character, but will not transmit the check character with the scanned data.





Codabar Concatenation

Codabar supports symbol concatenation. When you enable concatenation, the scanner looks for a Codabar symbol having a “D” start character, adjacent to a symbol having a “D” stop character. In this case the two messages are concatenated into one with the “D” characters omitted.



Select Require to prevent the scanner from decoding a single “D” Codabar symbol without its companion. This selection has no effect on Codabar symbols without Stop/Start D characters.



Codabar Message Length

Scan the bar codes below to change the message length. Refer to [Message Length Description](#) (page 6-1) for additional information. Minimum and Maximum lengths = 2-60. Minimum Default = 4, Maximum Default = 60.



Code 39

< Default All Code 39 Settings >



Code 39 On/Off



Code 39 Start/Stop Characters

Start/Stop characters identify the leading and trailing ends of the bar code. You may either transmit, or not transmit Start/Stop characters. *Default = Don't Transmit.*



Code 39 Check Character

No Check Character indicates that the scanner reads and transmits bar code data with or without a check character.

When Check Character is set to **Validate, but Don't Transmit**, the unit only reads Code 39 bar codes printed with a check character, but will not transmit the check character with the scanned data.

When Check Character is set to **Validate and Transmit**, the scanner only reads Code 39 bar codes printed with a check character, and will transmit this character at the end of the scanned data. *Default = No Check Character.*



Code 39 Message Length

Scan the bar codes below to change the message length. Refer to [Message Length Description](#) (page 6-1) for additional information. Minimum and Maximum lengths = 0-48. Minimum Default = 0, Maximum Default = 48.



C39MIN.

Minimum Message Length



C39MAX.

Maximum Message Length

Code 39 Append

This function allows the scanner to append the data from several Code 39 bar codes together before transmitting them to the host computer. When the scanner encounters a Code 39 bar code with the append trigger character(s), it buffers Code 39 bar codes until it reads a Code 39 bar code that does not have the append trigger. The data is then transmitted in the order in which the bar codes were read (FIFO). *Default = Off.*



C39APP1.

On



C39APP0.

* Off

Code 32 Pharmaceutical (PARAF)

Code 32 Pharmaceutical is a form of the Code 39 symbology used by Italian pharmacies. This symbology is also known as PARAF.

Note: Trioptic Code (page 6-30) must be turned off while scanning Code 32 Pharmaceutical codes.



C39B321.

On



C39B320.

* Off

Full ASCII

If Full ASCII Code 39 decoding is enabled, certain character pairs within the bar code symbol will be interpreted as a single character. For example: \$V will be decoded as the ASCII character SYN, and /C will be decoded as the ASCII character #. *Default = Off.*

NUL %U	DLE \$P	SP SPACE	0 0	@ %V	P P	' %W	p +P
SOH \$A	DC1 \$Q	! /A	1 1	A A	Q Q	a +A	q +Q
STX \$B	DC2 \$R	" /B	2 2	B B	R R	b +B	r +R
ETX \$C	DC3 \$S	# /C	3 3	C C	S S	c +C	s +S
EOT \$D	DC4 \$T	\$ /D	4 4	D D	T T	d +D	t +T
ENQ \$E	NAK \$U	% /E	5 5	E E	U U	e +E	u +U
ACK \$F	SYN \$V	& /F	6 6	F F	V V	f +F	v +V
BEL \$G	ETB \$W	' /G	7 7	G G	W W	g +G	w +W
BS \$H	CAN \$X	(/H	8 8	H H	X X	h +H	x +X
HT \$I	EM \$Y) /I	9 9	I I	Y Y	i +I	y +Y
LF \$J	SUB \$Z	* /J	: /Z	J J	Z Z	j +J	z +Z
VT \$K	ESC %A	+ /K	; %F	K K	[%K	k +K	{ %P
FF \$L	FS %B	, /L	< %G	L L	\ %L	l +L	%Q
CR \$M	GS %C	- -	= %H	M M] %M	m +M	} %R
SO \$N	RS %D	. .	> %I	N N	^ %N	n +N	~ %S
SI \$O	US %E	/ /O	? %J	O O	_ %O	o +O	DEL %T

Character pairs /M and /N decode as a minus sign and period respectively.

Character pairs /P through /Y decode as 0 through 9.



C39ASC1.
Full ASCII On



C39ASC0.
* Full ASCII Off

Code 39 Code Page

Code pages define the mapping of character codes to characters. If the data received does not display with the proper characters, it may be because the bar code being scanned was created using a code page that is different from the one the host program is expecting. If this is the case, scan the bar code below, select the code page with which the bar codes were created (see [ISO 2022/ISO 646 Character Replacements](#) on page A-8), and scan the value and the **Save** bar code from the [Programming Chart](#) on the inside the back cover of this manual. The data characters should then appear properly.



C39DCP.
Code 39 Code Page

Interleaved 2 of 5

< Default All Interleaved 2 of 5 Settings >



Interleaved 2 of 5 On/Off



Check Digit

No Check Digit indicates that the scanner reads and transmits bar code data with or without a check digit.

When Check Digit is set to **Validate, but Don't Transmit**, the unit only reads Interleaved 2 of 5 bar codes printed with a check digit, but will not transmit the check digit with the scanned data.

When Check Digit is set to **Validate and Transmit**, the scanner only reads Interleaved 2 of 5 bar codes printed with a check digit, and will transmit this digit at the end of the scanned data. *Default = No Check Digit.*



Interleaved 2 of 5 Message Length

Scan the bar codes below to change the message length. Refer to [Message Length Description](#) (page 6-1) for additional information. Minimum and Maximum lengths = 2-80. Minimum Default = 4, Maximum Default = 80.





NEC 2 of 5

< Default All NEC 2 of 5 Settings >



NEC 2 of 5 On/Off



Check Digit

No Check Digit indicates that the scanner reads and transmits bar code data with or without a check digit.

When Check Digit is set to **Validate, but Don't Transmit**, the unit only reads NEC 2 of 5 bar codes printed with a check digit, but will not transmit the check digit with the scanned data.

When Check Digit is set to **Validate and Transmit**, the scanner only reads NEC 2 of 5 bar codes printed with a check digit, and will transmit this digit at the end of the scanned data. *Default = No Check Digit.*



NEC 2 of 5 Message Length

Scan the bar codes below to change the message length. Refer to [Message Length Description](#) (page 6-1) for additional information. Minimum and Maximum lengths = 2-80. Minimum Default = 4, Maximum Default = 80.



N25MIN.

Minimum Message Length



N25MAX.

Maximum Message Length

Code 93

< Default All Code 93 Settings >



C93DFT.

Code 93 On/Off



C93ENA1.

* On



C93ENA0.

Off

Code 93 Message Length

Scan the bar codes below to change the message length. Refer to [Message Length Description](#) (page 6-1) for additional information. Minimum and Maximum lengths = 0-80. Minimum Default = 0, Maximum Default = 80.



C93MIN.

Minimum Message Length



C93MAX.

Maximum Message Length

Code 93 Append

This function allows the scanner to append the data from several Code 93 bar codes together before transmitting them to the host computer. When this function is enabled, the scanner stores those Code 93 bar codes that start with a space (excluding the start and stop symbols), and does not immediately transmit the data. The scanner stores the data in the order in which the bar codes are read, deleting the first space from each. The scanner transmits the appended data when it reads a Code 93 bar code that starts with a character other than a space. *Default = Off.*



Code 93 Code Page

Code pages define the mapping of character codes to characters. If the data received does not display with the proper characters, it may be because the bar code being scanned was created using a code page that is different from the one the host program is expecting. If this is the case, scan the bar code below, select the code page with which the bar codes were created (see [ISO 2022/ISO 646 Character Replacements](#) on page A-8), and scan the value and the **Save** bar code from the [Programming Chart](#) on the inside the back cover of this manual. The data characters should then appear properly.



Straight 2 of 5 Industrial (three-bar start/stop)

<Default All Straight 2 of 5 Industrial Settings>



R25DFT.

Straight 2 of 5 Industrial On/Off



R25ENA1.

On



R25ENA0.

*** Off**

Straight 2 of 5 Industrial Message Length

Scan the bar codes below to change the message length. Refer to [Message Length Description](#) (page 6-1) for additional information. Minimum and Maximum lengths = 1-48. Minimum Default = 4, Maximum Default = 48.



R25MIN.

Minimum Message Length



R25MAX.

Maximum Message Length

Straight 2 of 5 IATA (two-bar start/stop)

<Default All Straight 2 of 5 IATA Settings>



A25DFT.

Straight 2 of 5 IATA On/Off



A25ENA1.

On



A25ENA0.

*** Off**

Straight 2 of 5 IATA Message Length

Scan the bar codes below to change the message length. Refer to [Message Length Description](#) (page 6-1) for additional information. Minimum and Maximum lengths = 1-48. Minimum Default = 4, Maximum Default = 48.



A25MIN.

Minimum Message Length



A25MAX.

Maximum Message Length

Matrix 2 of 5

<Default All Matrix 2 of 5 Settings>



Matrix 2 of 5 On/Off



Matrix 2 of 5 Message Length

Scan the bar codes below to change the message length. Refer to [Message Length Description](#) (page 6-1) for additional information. Minimum and Maximum lengths = 1-80. Minimum Default = 4, Maximum Default = 80.



Code 11

<Default All Code 11 Settings>



Code 11 On/Off



Check Digits Required

This option sets whether 1 or 2 check digits are required with Code 11 bar codes. *Default = Two Check Digits.*



Code 11 Message Length

Scan the bar codes below to change the message length. Refer to [Message Length Description](#) (page 6-1) for additional information. Minimum and Maximum lengths = 1-80. Minimum Default = 4, Maximum Default = 80.



Code 128

<Default All Code 128 Settings>



Code 128 On/Off



ISBT 128 Concatenation

In 1994 the International Society of Blood Transfusion (ISBT) ratified a standard for communicating critical blood information in a uniform manner. The use of ISBT formats requires a paid license. The ISBT 128 Application Specification describes 1) the critical data elements for labeling blood products, 2) the current recommendation to use Code 128 due to its high degree of security and its space-efficient design, 3) a variation of Code 128 that supports concatenation of neighboring symbols, and 4) the standard layout for bar codes on a blood product label. Use the bar codes below to turn concatenation on or off. *Default =Off.*



Code 128 Message Length

Scan the bar codes below to change the message length. Refer to [Message Length Description](#) (page 6-1) for additional information. Minimum and Maximum lengths = 0-80. Minimum Default = 0, Maximum Default = 80.



Code 128 Append

This function allows the scanner to append the data from several Code 128 bar codes together before transmitting them to the host computer. When the scanner encounters a Code 128 bar code with the append trigger character(s), it buffers Code 128 bar codes until it reads a Code 128 bar code that does not have the append trigger. The data is then transmitted in the order in which the bar codes were read (FIFO). *Default = On.*



128APP1.

* On



128APP0.

Off

Code 128 Code Page

Code pages define the mapping of character codes to characters. If the data received does not display with the proper characters, it may be because the bar code being scanned was created using a code page that is different from the one the host program is expecting. If this is the case, scan the bar code below, select the code page with which the bar codes were created (see [ISO 2022/ISO 646 Character Replacements](#) on page A-8), and scan the value and the **Save** bar code from the [Programming Chart](#) on the inside the back cover of this manual. The data characters should then appear properly.



128DCP.

Code 128 Code Page

GS1-128

<Default All GS1-128 Settings>



GS1-128 On/Off



GS1-128 Message Length

Scan the bar codes below to change the message length. Refer to [Message Length Description](#) (page 6-1) for additional information. Minimum and Maximum lengths = 1-80. Minimum Default = 1, Maximum Default = 80.



UPC-A

<Default All UPC-A Settings>



UPC-A On/Off



Note: To convert UPC-A bar codes to EAN-13, see [Convert UPC-A to EAN-13](#) on page 6-23.

UPC-A Check Digit

This selection allows you to specify whether the check digit should be transmitted at the end of the scanned data or not.
Default = On.



UPC-A Number System

The numeric system digit of a U.P.C. symbol is normally transmitted at the beginning of the scanned data, but the unit can be programmed so it will not transmit it. *Default = On.*



UPC-A Addenda

This selection adds 2 or 5 digits to the end of all scanned UPC-A data.
Default = Off for both 2 Digit and 5 Digit Addenda.



UPC-A Addenda Required

When **Required** is scanned, the scanner will only read UPC-A bar codes that have addenda. You must then turn on a 2 or 5 digit addenda listed on [page 6-18](#). *Default = Not Required.*



UPAARQ1.
Required



UPAARQ0.
*** Not Required**

UPC-A Addenda Separator

When this feature is on, there is a space between the data from the bar code and the data from the addenda. When turned off, there is no space. *Default = On.*



UPAADS1.
*** On**



UPAADS0.
Off

UPC-A/EAN-13 with Extended Coupon Code

Use the following codes to enable or disable UPC-A **and** EAN-13 with Extended Coupon Code. When left on the default setting (**Off**), the scanner treats Coupon Codes and Extended Coupon Codes as single bar codes.

If you scan the **Allow Concatenation** code, when the scanner sees the coupon code and the extended coupon code in a single scan, it transmits both as one symbology. Otherwise, it transmits the first coupon code it reads.

If you scan the **Require Concatenation** code, the scanner must see and read the coupon code and extended coupon code in a single read to transmit the data. No data is output unless both codes are read. *Default = Off.*



CPNENA0.
*** Off**



CPNENA1.
Allow Concatenation



CPNENA2.
Require Concatenation

Coupon GS1 DataBar Output

If you scan coupons that have both UPC and GS1 DataBar codes, you may wish to scan and output only the data from the GS1 DataBar code. Scan the **GS1 Output On** code below to scan and output only the GS1 DataBar code data. *Default = GS1 Output Off.*



UPC-E0

<Default All UPC-E Settings>



UPC-E0 On/Off

Most U.P.C. bar codes lead with the 0 number system. To read these codes, use the **UPC-E0 On** selection. If you need to read codes that lead with the 1 number system, use [UPC-E1](#) (page 6-22). *Default = On.*



UPC-E0 Expand

UPC-E Expand expands the UPC-E code to the 12 digit, UPC-A format. *Default = Off.*



UPC-E0 Addenda Required

When **Required** is scanned, the scanner will only read UPC-E bar codes that have addenda. *Default = Not Required.*



UPEARQ1.

Required



UPEARQ0.

*** Not Required**

UPC-E0 Addenda Separator

When this feature is **On**, there is a space between the data from the bar code and the data from the addenda. When turned **Off**, there is no space. *Default = On.*



UPEADS1.

*** On**



UPEADS0.

Off

UPC-E0 Check Digit

Check Digit specifies whether the check digit should be transmitted at the end of the scanned data or not. *Default = On.*



UPECKX1.

*** On**



UPECKX0.

Off

UPC-E0 Leading Zero

This feature allows the transmission of a leading zero (0) at the beginning of scanned data. To prevent transmission, scan **Off**. *Default = On.*



UPENSX1.

*** On**



UPENSX0.

Off

UPC-E0 Addenda

This selection adds 2 or 5 digits to the end of all scanned UPC-E data. *Default = Off for both 2 Digit and 5 Digit Addenda.*



UPEAD21.

2 Digit Addenda On



UPEAD20.

*** 2 Digit Addenda Off**



UPEAD51.

5 Digit Addenda On



UPEAD50.

*** 5 Digit Addenda Off**

UPC-E1

Most U.P.C. bar codes lead with the 0 number system. For these codes, use [UPC-E0](#) (page 6-20). If you need to read codes that lead with the 1 number system, use the **UPC-E1 On** selection. *Default = Off.*



UPEEN11.

UPC-E1 On



UPEEN10.

*** UPC-E1 Off**

EAN/JAN-13

<Default All EAN/JAN Settings>



EAN/JAN-13 On/Off



Convert UPC-A to EAN-13

When **UPC-A Converted to EAN-13** is selected, UPC-A bar codes are converted to 13 digit EAN-13 codes by adding a zero to the front. When **Do not Convert UPC-A** is selected, UPC-A codes are read as UPC-A.



EAN/JAN-13 Check Digit

This selection allows you to specify whether the check digit should be transmitted at the end of the scanned data or not.
Default = On.



EAN/JAN-13 Addenda

This selection adds 2 or 5 digits to the end of all scanned EAN/JAN-13 data. *Default = Off for both 2 Digit and 5 Digit Addenda.*



E13AD21.
2 Digit Addenda On



E13AD20.
*** 2 Digit Addenda Off**



E13AD51.
5 Digit Addenda On



E13AD50.
*** 5 Digit Addenda Off**

EAN/JAN-13 Addenda Required

When **Required** is scanned, the scanner will only read EAN/JAN-13 bar codes that have addenda. *Default = Not Required.*



E13ARQ1.
Required



E13ARQ0.
*** Not Required**

EAN/JAN-13 Addenda Separator

When this feature is **On**, there is a space between the data from the bar code and the data from the addenda. When turned **Off**, there is no space. *Default = On.*



E13ADS1.
*** On**



E13ADS0.
Off

Note: If you want to enable or disable EAN13 with Extended Coupon Code, refer to [UPC-A/EAN-13 with Extended Coupon Code](#) (page 6-19).

ISBN Translate

When **On** is scanned, EAN-13 Bookland symbols are translated into their equivalent ISBN number format. *Default = Off.*



E13ISB1.
On



E13ISB0.
* Off

EAN/JAN-8

<Default All EAN/JAN-8 Settings>



EA8DFT.

EAN/JAN-8 On/Off



EA8ENA1.
* On



EA8ENA0.
Off

EAN/JAN-8 Check Digit

This selection allows you to specify whether the check digit should be transmitted at the end of the scanned data or not.
Default = On.



EA8CKX1.
* On



EA8CKX0.
Off

EAN/JAN-8 Addenda

This selection adds 2 or 5 digits to the end of all scanned EAN/JAN-8 data. *Default = Off for both 2 Digit and 5 Digit Addenda.*



EAN/JAN-8 Addenda Required

When **Required** is scanned, the scanner will only read EAN/JAN-8 bar codes that have addenda. *Default = Not Required.*



EAN/JAN-8 Addenda Separator

When this feature is **On**, there is a space between the data from the bar code and the data from the addenda. When turned **Off**, there is no space. *Default = On.*



MSI

<Default All MSI Settings>



MSI On/Off



MSI Check Character

Different types of check characters are used with MSI bar codes. You can program the scanner to read MSI bar codes with Type 10 check characters. *Default = Validate Type 10, but Don't Transmit.*

When Check Character is set to **Validate Type 10/11 and Transmit**, the scanner will only read MSI bar codes printed with the specified type check character(s), and will transmit the character(s) at the end of the scanned data.

When Check Character is set to **Validate Type 10/11, but Don't Transmit**, the unit will only read MSI bar codes printed with the specified type check character(s), but will not transmit the check character(s) with the scanned data.





MSICK6.

Disable MSI Check Characters

MSI Message Length

Scan the bar codes below to change the message length. Refer to [Message Length Description](#) (page 6-1) for additional information. Minimum and Maximum lengths = 4-48. Minimum Default = 4, Maximum Default = 48.



MSIMIN.

Minimum Message Length



MSICK5.

**Validate Type 11 then
Type 10 Character and Transmit**



MSIMAX.

Maximum Message Length

GS1 DataBar Omnidirectional

< Default All GS1 DataBar Omnidirectional Settings >



GS1 DataBar Omnidirectional On/Off



GS1 DataBar Limited

< Default All GS1 DataBar Limited Settings >



GS1 DataBar Limited On/Off



GS1 DataBar Expanded

< Default All GS1 DataBar Expanded Settings >



GS1 DataBar Expanded On/Off



GS1 DataBar Expanded Message Length

Scan the bar codes below to change the message length. Refer to [Message Length Description](#) (page 6-1) for additional information. Minimum and Maximum lengths = 4-74. Minimum Default = 4, Maximum Default = 74.



Codablock A

<Default All Codablock A Settings>



Codablock A On/Off



Codablock A Message Length

Scan the bar codes below to change the message length. Refer to [Message Length Description](#) (page 6-1) for additional information. Minimum and Maximum lengths = 1-600. Minimum Default = 1, Maximum Default = 600.



CBAMIN.

Minimum Message Length



CBAMAX.

Maximum Message Length

Codablock F

<Default All Codablock F Settings>



CBFDFE.

Codablock F On/Off



CBFENA1.

On



CBFENA0.

*** Off**

Codablock F Message Length

Scan the bar codes below to change the message length. Refer to [Message Length Description](#) (page 6-1) for additional information. Minimum and Maximum lengths = 1-2048. Minimum Default = 1, Maximum Default = 2048.



CBFMIN.

Minimum Message Length



CBFMAX.

Maximum Message Length

PDF417

< Default All PDF417 Settings >



PDF417 On/Off



PDF417 Message Length

Scan the bar codes below to change the message length. Refer to [Message Length Description](#) (page 6-1) for additional information. Minimum and Maximum lengths = 1-2750. Minimum Default = 1, Maximum Default = 2750.



MacroPDF417

MacroPDF417 is an implementation of PDF417 capable of encoding very large amounts of data into multiple PDF417 bar codes. When this selection is enabled, these multiple bar codes are assembled into a single data string. *Default = On.*



MicroPDF417

< Default All MicroPDF417 Settings >



MicroPDF417 On/Off



MicroPDF417 Message Length

Scan the bar codes below to change the message length. Refer to [Message Length Description](#) (page 6-1) for additional information. Minimum and Maximum lengths = 1-366. Minimum Default = 1, Maximum Default = 366.



GS1 Composite Codes

Linear codes are combined with a unique 2D composite component to form a new class called GS1 Composite symbology. GS1 Composite symbologies allow for the co-existence of symbologies already in use. *Default = Off.*



UPC/EAN Version

Scan the **UPC/EAN Version On** bar code to decode GS1 Composite symbols that have a U.P.C. or an EAN linear component. (This does not affect GS1 Composite symbols with a GS1-128 or GS1 linear component.) *Default = UPC/EAN Version Off.*



Note: If you scan coupons that have both UPC and GS1 DataBar codes, you may wish to scan and output only the data from the GS1 DataBar code. See [Coupon GS1 DataBar Output](#) (page 6-20) for further information.

GS1 Composite Code Message Length

Scan the bar codes below to change the message length. Refer to [Message Length Description](#) (page 6-1) for additional information. Minimum and Maximum lengths = 1-2435. Minimum Default = 1, Maximum Default = 2435.



GS1 Emulation

The scanner can automatically format the output from any GS1 data carrier to emulate what would be encoded in an equivalent GS1-128 or GS1 DataBar symbol. GS1 data carriers include UPC-A and UPC-E, EAN-13 and EAN-8, ITF-14, GS1-128, and GS1-128 DataBar and GS1 Composites. (Any application that accepts GS1 data can be simplified since it only needs to recognize one data carrier type.)

If **GS1-128 Emulation** is scanned, all retail codes (U.P.C., UPC-E, EAN8, EAN13) are expanded out to 16 digits. If the AIM ID is enabled, the value will be the GS1-128 AIM ID,]C1 (see [Symbology Charts](#) on page A-1).

If **GS1 DataBar Emulation** is scanned, all retail codes (U.P.C., UPC-E, EAN8, EAN13) are expanded out to 16 digits. If the AIM ID is enabled, the value will be the GS1-DataBar AIM ID,]em (see [Symbology Charts](#) on page A-1).

If **GS1 Code Expansion Off** is scanned, retail code expansion is disabled, and UPC-E expansion is controlled by the [UPC-E0 Expand](#) (page 6-20) setting. If the AIM ID is enabled, the value will be the GS1-128 AIM ID,]C1 (see [Symbology Charts](#) on page A-1).

If **EAN8 to EAN13 Conversion** is scanned, all EAN8 bar codes are converted to EAN13 format.

Default = GS1 Emulation Off.





TCIF Linked Code 39 (TLC39)

This code is a composite code since it has a Code 39 linear component and a MicroPDF417 stacked code component. All bar code readers are capable of reading the Code 39 linear component. The MicroPDF417 component can only be decoded if **TLC39 On** is selected. The linear component may be decoded as Code 39 even if TLC39 is off. *Default = Off.*



QR Code

< Default All QR Code Settings >



QR Code On/Off

This selection applies to both QR Code and Micro QR Code.



QR Code Message Length

Scan the bar codes below to change the message length. Refer to [Message Length Description](#) (page 6-1) for additional information. Minimum and Maximum lengths = 1-7089. Minimum Default = 1, Maximum Default = 7089.



QRCMIN.

Minimum Message Length



QRCMAX.

Maximum Message Length

QR Code Append

This function allows the scanner to append the data from several QR Code bar codes together before transmitting them to the host computer. When the scanner encounters an QR Code bar code with the append trigger character(s), it buffers the number of QR Code bar codes determined by information encoded in those bar codes. Once the proper number of codes is reached, the data is output in the order specified in the bar codes. *Default = On.*



QRCAPP1.

* On



QRCAPP0.

Off

QR Code Page

QR Code pages define the mapping of character codes to characters. If the data received does not display with the proper characters, it may be because the bar code being scanned was created using a code page that is different from the one the host program is expecting. If this is the case, scan the bar code below, select the code page with which the bar codes were created (see [ISO 2022/ISO 646 Character Replacements](#) on page A-8), and scan the value and the **Save** bar code from the [Programming Chart](#) on the inside the back cover of this manual. The data characters should then appear properly.



QRCDP.

QR Code Page

Data Matrix

< Default All Data Matrix Settings >



Data Matrix On/Off



Data Matrix Message Length

Scan the bar codes below to change the message length. Refer to [Message Length Description](#) (page 6-1) for additional information. Minimum and Maximum lengths = 1-3116. Minimum Default = 1, Maximum Default = 3116.



Data Matrix Append

This function allows the scanner to append the data from several Data Matrix bar codes together before transmitting them to the host computer. When the scanner encounters an Data Matrix bar code with the append trigger character(s), it buffers the number of Data Matrix bar codes determined by information encoded in those bar codes. Once the proper number of codes is reached, the data is output in the order specified in the bar codes. *Default = On.*



Data Matrix Code Page

Data Matrix Code pages define the mapping of character codes to characters. If the data received does not display with the proper characters, it may be because the bar code being scanned was created using a code page that is different from the one the host program is expecting. If this is the case, scan the bar code below, select the code page with which the bar

codes were created (see [ISO 2022/ISO 646 Character Replacements](#) on page A-8), and scan the value and the **Save** bar code from the [Programming Chart](#) on the inside the back cover of this manual. The data characters should then appear properly.



MaxiCode

< Default All MaxiCode Settings >



MaxiCode On/Off



MaxiCode Message Length

Scan the bar codes below to change the message length. Refer to [Message Length Description](#) (page 6-1) for additional information. Minimum and Maximum lengths = 1-150. Minimum Default = 1, Maximum Default = 150.



Aztec Code

< Default All Aztec Code Settings >



Aztec Code On/Off



Aztec Code Message Length

Scan the bar codes below to change the message length. Refer to [Message Length Description](#) (page 6-1) for additional information. Minimum and Maximum lengths = 1-3832. Minimum Default = 1, Maximum Default = 3832.



Aztec Append

This function allows the scanner to append the data from several Aztec bar codes together before transmitting them to the host computer. When the scanner encounters an Aztec bar code with the append trigger character(s), it buffers the number of Aztec bar codes determined by information encoded in those bar codes. Once the proper number of codes is reached, the data is output in the order specified in the bar codes. *Default = On.*



Aztec Code Page

Aztec Code pages define the mapping of character codes to characters. If the data received does not display with the proper characters, it may be because the bar code being scanned was created using a code page that is different from the one the host program is expecting. If this is the case, scan the bar code below, select the code page with which the bar

codes were created (see [ISO 2022/ISO 646 Character Replacements](#) on page A-8), and scan the value and the **Save** bar code from the [Programming Chart](#) on the inside the back cover of this manual. The data characters should then appear properly.



Chinese Sensible (Han Xin) Code

< Default All Han Xin Settings >



Han Xin Code On/Off



Han Xin Code Message Length

Scan the bar codes below to change the message length. Refer to [Message Length Description](#) (page 6-1) for additional information. Minimum and Maximum lengths = 1-7833. Minimum Default = 1, Maximum Default = 7833.



Postal Codes - 2D

The following lists the possible 2D postal codes, and 2D postal code combinations that are allowed. Only one 2D postal code selection can be active at a time. If you scan a second 2D postal code selection, the first selection is overwritten. *Default = 2D Postal Codes Off.*



POSTAL0.

* 2D Postal Codes Off

Single 2D Postal Codes:



POSTAL1.

Australian Post On



POSTAL7.

British Post On



POSTAL30.

Canadian Post On



POSTAL10.

Intelligent Mail Bar Code On



POSTAL3.

Japanese Post On



POSTAL4.

KIX Post On



POSTAL5.

Planet Code On

Also see [Planet Code Check Digit](#), page 6-44.



POSTAL9.

Postal-4i On



POSTAL6.
Postnet On

Also see [Postnet Check Digit](#), page 6-44.



POSTAL11.
Postnet with B and B' Fields On



POSTAL2.
InfoMail On

Combination 2D Postal Codes:



POSTAL8.
InfoMail and British
Post On



POSTAL20.
Intelligent Mail Bar Code and
Postnet with B and B' Fields On



POSTAL14.
Postnet and
Postal-4i On



POSTAL16.
Postnet and
Intelligent Mail Bar Code On



POSTAL17.
Postal-4i and
Intelligent Mail Bar Code On



POSTAL19.
Postal-4i and
Postnet with B and B' Fields On



POSTAL12.
Planet Code and
Postnet On



POSTAL13.
Planet Code and
Postal-4i On



POSTAL21.
Planet Code,
Postnet, and
Postal-4i On



POSTAL23.
Planet Code,
Postal-4i, and
Intelligent Mail Bar Code On



POSTAL25.
Planet Code,
Postal-4i, and
Postnet with B and B' Fields On



POSTAL27.
Postal-4i,
Intelligent Mail Bar Code, and
Postnet with B and B' Fields On



POSTAL18.
Planet Code and
Postnet with B and B' Fields On



POSTAL15.
Planet Code and
Intelligent Mail Bar Code On



POSTAL22.
Planet Code,
Postnet, and
Intelligent Mail Bar Code On



POSTAL24.
Postnet,
Postal-4i, and
Intelligent Mail Bar Code On



POSTAL26.
Planet Code,
Intelligent Mail Bar Code, and
Postnet with B and B' Fields On



POSTAL28.
Planet Code,
Postal-4i,
Intelligent Mail Bar Code, and
Postnet On



POSTAL29.
Planet Code,
Postal-4i,
Intelligent Mail Bar Code, and
Postnet with B and B' Fields On

Planet Code Check Digit

This selection allows you to specify whether the check digit should be transmitted at the end of Planet Code data. *Default = Don't Transmit.*



PLNCKX1.
Transmit Check Digit



PLNCKXD.
* Don't Transmit Check Digit

Postnet Check Digit

This selection allows you to specify whether the check digit should be transmitted at the end of Postnet data. *Default = Don't Transmit.*



NETCKX1.
Transmit Check Digit



NETCKXD.
* Don't Transmit Check Digit

Australian Post Interpretation

This option controls what interpretation is applied to customer fields in Australian 4-State symbols.

Bar Output lists the bar patterns in "0123" format.

Numeric N Table causes that field to be interpreted as numeric data using the N Table.

Alphanumeric C Table causes the field to be interpreted as alphanumeric data using the C Table. Refer to the Australian Post Specification Tables.

Combination C and N Tables causes the field to be interpreted using either the C or N Tables.



AUSINT0.

* Bar Output



AUSINT1.

Numeric N Table



AUSINT2.

Alphanumeric C Table



AUSINT3.

Combination C and N Tables

Postal Codes - Linear

The following lists linear postal codes. Any combination of linear postal code selections can be active at a time.

China Post (Hong Kong 2 of 5)

<Default All China Post (Hong Kong 2 of 5) Settings>



CPCDFT.

China Post (Hong Kong 2 of 5) On/Off



CPCENA1.

On



CPCENAD.

* Off

China Post (Hong Kong 2 of 5) Message Length

Scan the bar codes below to change the message length. Refer to [Message Length Description](#) (page 6-1) for additional information. Minimum and Maximum lengths = 2-80. Minimum Default = 4, Maximum Default = 80.



CPCMIN.

Minimum Message Length



Korea Post

<Default All Korea Post Settings>



Korea Post



Korea Post Message Length

Scan the bar codes below to change the message length. Refer to [Message Length Description](#) (page 6-1) for additional information. Minimum and Maximum lengths = 2-80. Minimum Default = 4, Maximum Default = 48.



Korea Post Check Digit

This selection allows you to specify whether the check digit should be transmitted. *Default = Don't Transmit.*



Imaging Commands

The scan engine is like a digital camera in the way it captures, manipulates, and transfers images. The following commands allow you to alter the way the scan engine performs these functions.

Note: If you are using the scan engine in a stand, you must set the In-Stand Sensor Mode to Off in order to take images (see [Presentation Centering](#) on page 3-8).

Single-Use Basis

Imaging Commands with their modifiers send instructions to the scan engine on a single-use basis, and take effect for a single image capture. Once that capture is complete, the scan engine reverts to its imaging default settings. If you want to permanently change a setting, you must use the serial default commands (see [Chapter 9](#)). When the serial default command is used, that selection becomes the new, permanent setting for the scan engine.

Command Syntax

Multiple modifiers and commands can be issued within one sequence. If additional modifiers are to be applied to the same command, just add the modifiers to that command. For example, to add 2 modifiers to the Image Snap command, such as setting the Imaging Style to 1P and the Wait for Trigger to 1T, you would enter **IMGSNP1P1T**.

Note: After processing an image capture command (IMGSNP), you must follow it with an IMGSHIP command if you want to see it on your terminal.

To add a command to a sequence, each new command is separated with a semicolon. For example, to add the Image Ship command to the above sequence, you would enter **IMGSNP1P1T;IMGSHIP**.

The imaging commands are:

[Image Snap - IMGSNP](#) (page 7-1)

[Image Ship - IMGSHIP](#) (page 7-3)

The modifiers for each of these commands follow the command description.

Note: The images included with each command description are examples only. The results you achieve may be different from those included in this manual. The quality of the output you receive will vary depending on lighting, quality of the initial image/object being captured, and distance of the scan engine from the image/object. To achieve a high quality image, it is recommended that you position your scan engine 4-6" (10.2-15.2 cm) away from the image/object you are capturing.

Step 1 - Take a Picture Using IMGSNP

Image Snap - IMGSNP

An image is taken whenever the hardware button is pressed, or when the Image Snap (IMGSNP) command is processed.

The image snap command has many different modifiers that can be used to change the look of the image in memory. Any number of modifiers may be appended to the IMGSNP command. For example, you can use the following command to snap an image, increase the gain, and have the beeper sound once the snap is complete: **IMGSNP2G1B**

IMGSNP Modifiers

P - Imaging Style

This sets the Image Snap style.

- 0P **Decoding Style.** This processing allows a few frames to be taken until the exposure parameters are met. The last frame is then available for further use.
- 1P **Photo Style (default).** This mimics a simple digital camera, and results in a visually optimized image.
- 2P **Manual Style.** This is an advanced style that should only be used by an experienced user. It allows you the most freedom to set up the scan engine, and has no auto-exposure.

B - Beeper

Causes a beep to sound after an image is snapped.

- 0B No beep (*default*)

1B Sounds a beep when the image is captured.

T - Wait for Trigger

Waits for a hardware button push before taking the image. This is only available when using Photo Style (1P).

0T Takes image immediately (*default*)

1T Waits for a button push, then takes the image

L - LED State

Determines if the LEDs should be on or off, and when. Ambient illumination (0L) is preferred for taking pictures of color documents, such as ID cards, especially when the scan engine is in a stand. LED illumination (1L) is preferred when the scanner is handheld. LED State is not available when using Decoding Style (0P).

0L LEDs off (*default*)

1L LEDs on

E - Exposure

Exposure is used in Manual Style only (2P), and allows you to set the exposure time. This is similar to setting a shutter speed on a camera. The exposure time determines how long the scanner takes to record an image. On a bright day, exposure times can be very short because plenty of light is available to help record an image. At nighttime, exposure time can increase dramatically due to the near absence of light. Units are 127 microseconds. (*Default = 7874*)

nE Range: 1 - 7874

Example of Exposure at 7874E with fluorescent lighting:

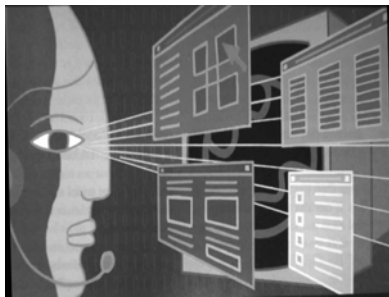

Example of Exposure at 100E with fluorescent lighting:



G - Gain

Gain is used in Manual Style only (2P). Like a volume control, the gain modifier boosts the signal and multiplies the pixel value. As you increase the gain, the noise in an image is also amplified.

40G Medium gain

64G Heavy gain (*default*)

96G Maximum gain

Example of Gain at 40G:

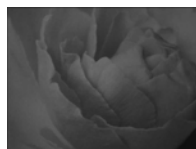

Example of Gain at 64G:

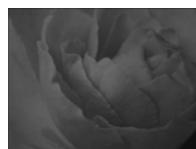

Example of Gain at 96G:



W - Target White Value

Sets the target for the median grayscale value in the captured image. For capturing close-up images of high contrast documents, a lower setting, such as 75, is recommended. Higher settings result in longer exposure times and brighter images, but if the setting is too high, the image may be overexposed. Target White Value is only available when using Photo Style (1P). (Default = 90)

nW Range: 0 - 255

Example of White Value at 75W:



Example of White Value at 125W:



Example of White Value at 200W:



D - Delta for Acceptance

This sets the allowable range for the white value setting (see [W - Target White Value](#)). Delta is only available when using Photo Style (1P). (Default = 25)

nD Range: 0 - 255

U - Update Tries

This sets the maximum number of frames the scan engine should take to reach the [D - Delta for Acceptance](#). Update Tries is only available when using Photo Style (1P). (Default = 6)

nU Range: 0 - 10

% - Target Set Point Percentage

Sets the target point for the light and dark values in the captured image. A setting of 75% means 75% of the pixels are at or below the target white value, and 25% of the pixels are above the target white value. Altering this setting from the default is not recommended under normal circumstances. To alter grayscale values, [W - Target White Value](#) should be used. (Default = 50)

n% Range: 1 - 99

Example of Target Set Point Percentage at 97%:

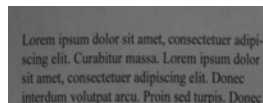

Example of Target Set Point Percentage at 50%:

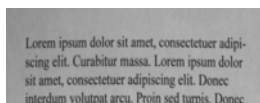

Example of Target Set Point Percentage at 40%:

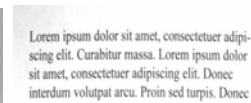

Step 2 - Ship a Picture Using IMGSHIP

Image Ship - IMGSHIP

An image is taken whenever the button is pressed, or when the Image Snap (IMGSNP) command is processed. The last image is always stored in memory. You can “ship” the image by using the IMGSHIP command.

The image ship commands have many different modifiers that can be used to change the look of the image output. Modifiers affect the image that is transmitted, but do not affect the image in memory. Any number of modifiers may be appended to the IMGSHIP command. For example, you can use the following command to snap and ship a bitmap image with gamma correction and document image filtering: **IMGSNP;IMGSHIP8F75K26U**

IMGSHIP Modifiers

A - Infinity Filter

Enhances pictures taken from very long distances (greater than 10 feet or 3m). The Infinity Filter should not be used with [IMGSNP Modifiers](#) (page 7-1).

- 0A Infinity filter off (*default*)
- 1A Infinity filter on

Example of Infinity Filter off (0A)
from approximately 12 feet
(3.66m) away:

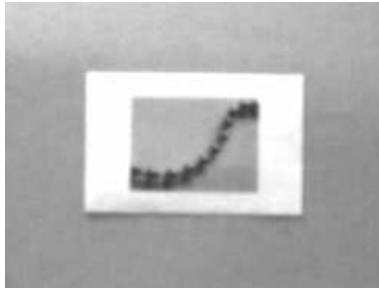

Example of Infinity Filter on (1A)
from approximately 12 feet (3.66m)
away:

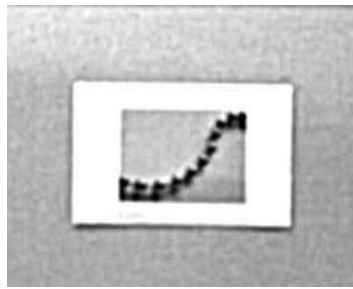

C - Compensation

Flattens the image to account for variations in illumination across the image.

- 0C Compensation disabled (*default*)
- 1C Compensation enabled

Example of Compensation at 0C:



Example of Compensation at 1C:



D - Pixel Depth

Indicates the number of bits per pixel in the transmitted image (KIM or BMP format only).

- 8D 8 bits per pixel, grayscale image (*default*)
- 1D 1 bit per pixel, black and white image

E - Edge Sharpen

An edge sharpen filter cleans up the edges of an image, making it look cleaner and sharper. While edge sharpening does make the image look cleaner, it also removes some fine detail from the original image. The strength of the edge sharpen filter can be entered from 1 to 24. Entering a 23E gives the sharpest edges, but also increases noise in the image.

- 0E Don't sharpen image (*default*)
- 14E Apply edge sharpen for typical image
- ne Apply edge sharpen using strength n ($n = 1-24$)

Example of Edge Sharpen at 0E:



Example of Edge Sharpen at 24E:

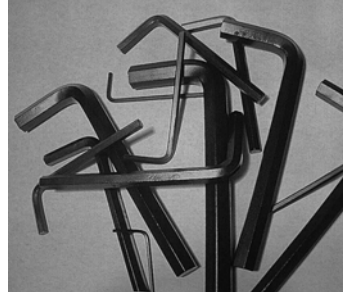

F - File Format

Indicates the desired format for the image.

- 0F KIM format
- 1F TIFF binary
- 2F TIFF binary group 4, compressed
- 3F TIFF grayscale
- 4F Uncompressed binary (upper left to lower right, 1 pixel/bit, 0 padded end of line)
- 5F Uncompressed grayscale (upper left to lower right, bitmap format)
- 6F JPEG image (*default*)
- 8F BMP format (lower right to upper left, uncompressed)
- 15F BMP Uncompressed raw image

H - Histogram Stretch

Increases the contrast of the transmitted image. Not available with some image formats.

- 0H No stretch (*default*)
- 1H Histogram stretch

Example of Histogram Stretch at 0H:



Example of Histogram Stretch at 1H:



I - Invert Image

Invert image is used to rotate the image around the X or Y axis.

- 1ix Invert around the X axis (flips picture upside down)

1iy Invert around the Y axis (flips picture left to right)

Example of image not inverted:



Example of image with Invert Image set to 1ix:



Example of image with Invert Image set to 1iy:



IF- Noise Reduction

Used to reduce the salt and pepper noise in an image.

0if No salt and pepper noise reduction (default)

1if Salt and pepper noise reduction

Example of Noise Reduction Off (0if):



Example of Noise Reduction On (1if):



IR - Image Rotate

- 0ir Image as snapped (rightside up) (default)
- 1ir Rotate image 90 degrees to the right
- 2ir Rotate image 180 degrees (upside down)
- 3ir Rotate image 90 degrees to the left

Example of Image Rotate set to 0ir:



Example of Image Rotate set to 2ir:



Example of Image Rotate set to 1ir:



Example of Image Rotate set to 3ir:



J - JPEG Image Quality

Sets the desired quality when the JPEG image format is selected. Higher numbers result in higher quality, but larger files. Smaller numbers result in greater amounts of lossy compression, faster transmission times, lower quality, but smaller files. (Default = 50)

- nJ Image is compressed as much as possible while preserving quality factor of n ($n = 0 - 100$)
- 0J worst quality (smallest file)
- 100J best quality (largest file)

K - Gamma Correction

Gamma measures the brightness of midtone values produced by the image. You can brighten or darken an image using gamma correction. A higher gamma correction yields an overall brighter image. The lower the setting, the darker the image. The optimal setting for text images is 50K.

- 0K Gamma correction off (default)
- 50K Apply gamma correction for brightening typical document image
- nK Apply gamma correction factor n ($n = 0-1,000$)

Example of Gamma Correction set to 0K:



Example of Gamma Correction set to 50K:



Example of Gamma Correction set to 255K:



L, R, T, B, M - Image Cropping

Ships a window of the image by specifying the left, right, top, and bottom pixel coordinates. Device columns are numbered 0 through 1279, and device rows are numbered 0 through 959.

- nL* The left edge of the shipped image corresponds to column *n* of the image in memory. Range: 000 - 843. (*Default = 0*)
- nR* The right edge of the shipped image corresponds to column *n - 1* of the image in memory. Range: 000 - 843. (*Default = all columns*)
- nT* The top edge of the shipped image corresponds to row *n* of the image in memory. Range: 000 - 639. (*Default = 0*)
- nB* The bottom edge of the shipped image corresponds to row *n - 1* of the image in memory. Range: 000 - 639. (*Default = all rows*)

Uncropped Image:



Example of Image Crop set to 300R:



Example of Image Crop set to 300L:

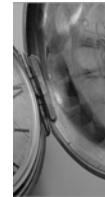

Example of Image Crop set to 200B:



Example of Image Crop set to 200T:



Alternately, specify the number of pixels to cut from the outside margin of the image; thus only the center pixels are transmitted.

- nM* Margin: cut *n* columns from the left, *n + 1* columns from the right, *n* rows from the top, and *n + 1* rows from the bottom of the image. Ship the remaining center pixels. Range: 0 - 238. (*Default = 0, or full image*)

Example of Image Crop set to 238M:



P - Protocol

Used for shipping an image. Protocol covers two features of the image data being sent to the host. It addresses the protocol used to send the data (Hmodem, which is an Xmodem 1K variant that has additional header information), and the format of the image data that is sent.

- 0P None (raw data)
- 2P None (*default for USB*)
- 3P Hmodem compressed (*default for RS232*)
- 4P Hmodem

S - Pixel Ship

Pixel Ship sizes an image in proportion to its original size. It decimates the image by shipping only certain, regularly spaced pixels. For example, **4S** would transmit every fourth pixel from every fourth line. The smaller number of pixels shipped, the smaller the image, however, after a certain point the image becomes unusable.

- 1S ship every pixel (*default*)
- 2S ship every 2nd pixel, both horizontally and vertically

3S ship every 3rd pixel, both horizontally and vertically

Example of Pixel Ship set to 1S:



Example of Pixel Ship set to 2S:



Example of Pixel Ship set to 3S:



U - Document Image Filter

Allows you to input parameters to sharpen the edges and smooth the area between the edges of text in an image. This filter should be used with gamma correction (see [page 7-7](#)), with the scan engine in a stand, and the image captured using the command:

IMGSNP1P0L168W90%32D

This filter typically provides better JPEG compression than the standard E - Edge Sharpen command (see [page 7-9](#)). This filter also works well when shipping pure black and white images (1 bit per pixel). The optimal setting is 26U.

0U Document image filter off (*default*)

26U Apply document image filter for typical document image

nU Apply document image filter using grayscale threshold n. Use lower numbers when the image contrast is lower. 1U will have a similar effect to setting [E - Edge Sharpen](#) (page 7-5) to 22e. Range: 0-255.

Example of Document Image Filter set to 0U:



Example of Document Image Filter set to 26U:



V - Blur Image

Smooths transitions by averaging the pixels next to the hard edges of defined lines and shaded areas in an image.

0V Don't blur (*default*)

1V Blur

Example of Blur Image Off (0V):



Example of Blur Image On (1V):



W - Histogram Ship

A histogram gives a quick picture of the tonal range of an image, or key type. A low-key image has detail concentrated in the shadows; a high-key image has detail concentrated in the highlights; and an average-key image has detail concentrated in the midtones. This modifier ships the histogram for an image.

0W Don't ship histogram (*default*)

1W Ship histogram

Image used for histogram:

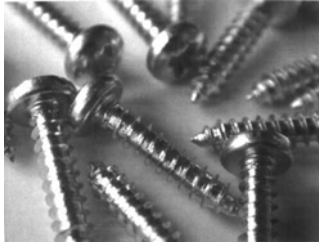

Histogram of image at left:



To Add a Test Code I.D. Prefix to All Symbologies

This selection allows you to turn on transmission of a Code I.D. before the decoded symbology. (See the [Symbology Charts](#), beginning on page A-1) for the single character code that identifies each symbology.) This action first clears all current prefixes, then programs a Code I.D. prefix for all symbologies. This is a temporary setting that will be removed when the unit is power cycled.



PRECA2,BK2995C80!

**Add Code I.D. Prefix to
All Symbologies (Temporary)**

Show Decoder Revision

Scan the bar code below to output the decoder revision.



REV_DR.

Show Decoder Revision

Show Scan Driver Revision

Scan the bar code below to output the scan driver revision. The scan driver controls image capture.



REV_SD.

Show Scan Driver Revision

Show Software Revision

Scan the bar code below to output the current software revision, unit serial number, and other product information for both the scan engine and base.



REVINP.

Show Software Revision

Show Data Format

Scan the bar code below to show current data format settings.



DFMBK3?.

Data Format Settings

Test Menu

When you scan the Test Menu **On** code, then scan a programming code in this manual, the scan engine displays the content of a programming code. The programming function will still occur, but in addition, the content of that programming code is output to the terminal.

Note: This feature should not be used during normal scan engine operation.



EZConfig-Scanning Introduction

EZConfig-Scanning provides a wide range of PC-based programming functions that can be performed on a scan engine connected to your PC's COM port. EZConfig-Scanning allows you to download upgrades to the scan engine's firmware, change programmed parameters, and create and print programming bar codes. Using EZConfig-Scanning, you can even save/open the programming parameters for a scan engine. This saved file can be e-mailed or, if required, you can create a single bar code that contains all the customized programming parameters and mail or fax that bar code to any location. Users in other locations can scan the bar code to load in the customized programming.

EZConfig-Scanning Operations

The EZConfig-Scanning software performs the following operations:

Scan Data

Scan Data allows you to scan bar codes and display the bar code data in a window. Scan Data lets you send serial commands to the scan engine and receive a scan engine response that can be seen in the Scan Data window. The data displayed in the Scan Data window can either be saved in a file or printed.

Configure

Configure displays the programming and configuration data of the scan engine. The scan engine's programming and configuration data is grouped into different categories. Each category is displayed as a tree item under the "Configure" tree node in the application explorer. When one of these tree nodes is clicked, the right-hand side is loaded with the parameters' form belonging to that particular category. The "Configure" tree option has all the programming and configuration parameters specified for a scan engine. You can set or modify these parameters as required. You can later write the modified settings to the scan engine, or save them to a dcf file.

Imaging

Imaging provides all the image-related functions that a 2D scan engine can perform. You can capture an image using the current settings, and the image will be displayed in an image window. Images captured from the scan engine can be saved to files in different image formats. You can modify the image settings and save the image settings to an INI file, which can be loaded later to capture new images. Imaging also lets you preview the images continuously captured by the scan engine.

Installing EZConfig-Scanning from the Web

Note: EZConfig-Scanning requires .NET software. If .NET is not installed on your PC, you will be prompted to install it during the EZConfig-Scanning installation.

1. Access the Honeywell web site at www.honeywellaidc.com
2. Click on the **Products** tab. Under **Software**, select **Device Management**.

-
3. Click on **EZConfig-Device Configuration Software**.
 4. Click on the **Software** tab. Select **EZConfig Cloud For Scanning** (online version, must register for access) or **EZConfig for Scanning** (to install on your PC, follow the next steps).
 5. To install on your PC, when prompted, select **Save File**, and save the files to the **c:\windows\temp** directory.
 6. Once you have finished downloading the file, exit the web site.
 7. Using Explorer, go to the **c:\windows\temp** file.
 8. Double click on the **Setup.exe** file. Follow the screen prompts to install the EZConfig-Scanning program.
 9. If you've selected the defaults during installation, you can click on **Start Menu-All Programs-Honeywell-EZConfig-Scanning** and select EZConfig for your browser.

Resetting the Factory Defaults



This selection erases all your settings and resets the scan engine to the original factory defaults. It also disables all plugins.

If you aren't sure what programming options are in your scan engine, or you've changed some options and want to restore the scan engine to factory default settings, first scan the **Remove Custom Defaults** bar code, then scan **Activate Defaults**. This resets the scan engine to the factory default settings.



DEFOVR.

Remove Custom Defaults



DEFAULT.

Activate Defaults

The [Menu Commands](#), beginning on page 9-4 list the factory default settings for each of the commands (indicated by an asterisk (*) on the programming pages).



Serial Programming Commands

The serial programming commands can be used in place of the programming bar codes. Both the serial commands and the programming bar codes will program the scan engine. For complete descriptions and examples of each serial programming command, refer to the corresponding programming bar code in this manual.

The device must be set to an RS232 interface (see [page 2-1](#)). The following commands can be sent via a PC COM port using terminal emulation software.

Conventions

The following conventions are used for menu and query command descriptions:

parameter A label representing the actual value you should send as part of a command.

[*option*] An optional part of a command.

{*Data*} Alternatives in a command.

bold Names of menus, menu commands, buttons, dialog boxes, and windows that appear on the screen.

Menu Command Syntax

Menu commands have the following syntax (spaces have been used for clarity only):

Prefix Tag SubTag {Data} [, SubTag {Data}] [: Tag SubTag {Data}] [...] *Storage*

Prefix Three ASCII characters: **SYN M CR** (ASCII 22,77,13).

Tag A 3 character case-insensitive field that identifies the desired menu command group. For example, all RS-232 configuration settings are identified with a Tag of **232**.

SubTag A 3 character case-insensitive field that identifies the desired menu command within the tag group. For example, the SubTag for the RS-232 baud rate is **BAD**.

Data The new value for a menu setting, identified by the Tag and SubTag.

Storage A single character that specifies the storage table to which the command is applied:

! (exclamation point) => performs the command's operation on the device's volatile menu configuration table.

. (period) => performs the command's operation on the device's non-volatile menu configuration table. Use the non-volatile table only for semi-permanent changes you want saved through a power cycle.

IMPORTANT: The scan engine's flash has a limited number of write cycles. When sending commands frequently Honeywell recommends using the volatile (! exclamation point) memory as often as possible.

Serial Command Example

Set the RS232 baud rate to 115,200: *SYN M CR 232BAD9*. *or* *\x16M\x0D232BAD9*.

Prefix	Tag	SubTag	Data	Storage
<i>SYN M CR</i>	<i>232</i>	<i>BAD</i>	<i>9</i>	<i>.</i>

Query Commands

Several special characters can be used to query the device about its settings.

^ What is the default value for the setting(s).

? What is the device's current value for the setting(s).

***** What is the range of possible values for the setting(s). (The device's response uses a dash (-) to indicate a continuous range of values. A pipe (|) separates items in a list of non-continuous values.)

:Name: Field Usage (Optional)

This command returns the query information from the scan engine.

Tag Field Usage

When a query is used in place of a Tag field, the query applies to the *entire* set of commands available for the particular storage table indicated by the Storage field of the command. In this case, the SubTag and Data fields should not be used because they are ignored by the device.

SubTag Field Usage

When a query is used in place of a SubTag field, the query applies only to the subset of commands available that match the Tag field. In this case, the Data field should not be used because it is ignored by the device.

Data Field Usage

When a query is used in place of the Data field, the query applies only to the specific command identified by the Tag and SubTag fields.

Concatenation of Multiple Commands

Multiple commands can be issued within one Prefix/Storage sequence. Only the Tag, SubTag, and Data fields must be repeated for each command in the sequence. If additional commands are to be applied to the same Tag, then the new command sequence is separated with a comma (,) and only the SubTag and Data fields of the additional command are issued. If the additional command requires a different Tag field, the command is separated from previous commands by a semicolon (;).

Responses

The device responds to serial commands with one of three responses:

ACK Indicates a good command which has been processed.

ENQ Indicates an invalid Tag or SubTag command.

NAK Indicates the command was good, but the Data field entry was out of the allowable range for this Tag and SubTag combination, e.g., an entry for a minimum message length of 100 when the field will only accept 2 characters.

When responding, the device echoes back the command sequence with the status character inserted directly before each of the punctuation marks (the period, exclamation point, comma, or semicolon) in the command.

Examples of Query Commands

In the following examples, a bracketed notation [] depicts a non-displayable response.

Example: What is the range of possible values for Codabar Coding Enable?

Enter: **cbrena*.**

Response: **CBRENA0-1[ACK]**

This response indicates that Codabar Coding Enable (CBRENA) has a range of values from 0 to 1 (off and on).

Example: What is the default value for Codabar Coding Enable?

Enter: **cbrena^.**

Response: **CBRENA1[ACK]**

This response indicates that the default setting for Codabar Coding Enable (CBRENA) is 1, or on.

Example: What is the device's current setting for Codabar Coding Enable?

Enter: **cbrena?.**

Response: **CBRENA1[ACK]**

This response indicates that the device's Codabar Coding Enable (CBRENA) is set to 1, or on.

Example: What are the device's settings for all Codabar selections?

Enter: **cbr?.**

Response: **CBRENA1[ACK],
SSX0[ACK],**

**CK20[ACK],
CCT1[ACK],
MIN2[ACK],
MAX60[ACK],
DFT[ACK].**

This response indicates that the device's Codabar Coding Enable (CBRENA) is set to 1, or on; the Start/Stop Character (SSX) is set to 0, or Don't Transmit; the Check Character (CK2) is set to 0, or Not Required; concatenation (CCT) is set to 1, or Enabled; the Minimum Message Length (MIN) is set to 2 characters; the Maximum Message Length (MAX) is set to 60 characters; and the Default setting (DFT) has no value.

Trigger Commands

You can activate and deactivate the scan engine with serial trigger commands. First, the scan engine must be put in Manual Trigger Mode by scanning a Manual Trigger Mode bar code (page 3-5), or by sending a serial menu command for triggering (page 9-8). Once the scan engine is in serial trigger mode, the trigger is activated and deactivated by sending the following commands:

Activate: **SYN T CR**

Deactivate: **SYN U CR**

The scan engine scans until a bar code has been read, until the deactivate command is sent, or until the serial time-out has been reached (see "Read Time-Out" on page 3-7 for a description, and the serial command on page 9-9).

Setting the Custom Defaults

You can set the custom defaults by sending serial commands. Use the following concatenated command format to store custom defaults in your product:

MNUCDF;DEFOVR;<CMD1>;<CMD2>; ... <CMDX>;MNUCDS@

Set Custom Defaults	Remove Custom Default List	Menu Command List	Save Custom Defaults (@ = save to custom default table)
<i>MNUCDF</i>	<i>DEFOVR</i>	<i><CMD1>;<CMD2>; ... <CMDX></i>	<i>MNUCDS@</i>

The custom defaults are not applied immediately, to activate send the Activate Defaults command (or read the bar code below):
DEFAULT.

Resetting the Custom Defaults

If you want the custom default settings restored to your scan engine, scan the **Activate Custom Defaults** bar code below. This resets the scan engine to the custom default settings. If there are no custom defaults, it will reset the scan engine to the factory default settings. Any settings that have not been specified through the custom defaults will be defaulted to the factory default settings.



DEFAULT.

Activate Custom Defaults

The charts on the following pages list the factory default settings for each of the commands (indicated by an asterisk (*) on the programming pages).

Note: To remove custom defaults, see "Resetting the Factory Defaults" on page 8-3.

Menu Commands

Selection	Setting <i>* Indicates default</i>	Serial Command <i># Indicates a numeric entry</i>	Page
Product Default Settings			
Setting Custom Defaults	Set Custom Defaults	MNUCDF	1-5
	Save Custom Defaults	MNUCDS	1-5
Resetting the Custom Defaults	Activate Custom Defaults	DEFAULT	1-6
Programming the Interface			
RS232 Interface	RS232 Serial Port	TERMID0;232BAD9;232WRD2	2-1
Plug and Play Codes: USB	*USB Keyboard (PC)	PAP124	2-1
	USB Keyboard (Mac)	PAP125	2-1
	USB HID	TERMID131	2-1
	USB Serial	TERMID130	2-2
	ACK/NAK Mode On	USBACK1	2-2
	ACK/NAK Mode Off*	USBACK0	2-2
Plug and Play Codes	Verifone Ruby Terminal	PAPRBY	2-2
	Gilbarco Terminal	PAPGLB	2-3
	Honeywell Bioptic Aux Port	PAPBIO	2-3
	Datalogic Magellan Bioptic Aux Port	PAPMAG	2-3
	NCR Bioptic Aux Port	PAPNCR	2-3
	Wincor Nixdorf Terminal	PAPWNX	2-4
	Wincor Nixdorf Beetle	PAPBTL	2-4
	Wincor Nixdorf RS232 Mode A	PAPWMA	2-5
Program Keyboard Country	*U.S.A.	KBDCTY0	2-6
	Albania	KBDCTY35	2-6
	Azeri (Cyrillic)	KBDCTY81	2-6
	Azeri (Latin)	KBDCTY80	2-6
	Belarus	KBDCTY82	2-6
	Belgium	KBDCTY1	2-6
	Bosnia	KBDCTY33	2-6
	Brazil	KBDCTY16	2-6
	Brazil (MS)	KBDCTY59	2-6
	Bulgaria (Cyrillic)	KBDCTY52	2-6
	Bulgaria (Latin)	KBDCTY53	2-7
	Canada (French legacy)	KBDCTY54	2-7
	Canada (French)	KBDCTY18	2-7
	Canada (Multilingual)	KBDCTY55	2-7
	Croatia	KBDCTY32	2-7
	Czech	KBDCTY15	2-7
	Czech (Programmers)	KBDCTY40	2-7
	Czech (QWERTY)	KBDCTY39	2-7
Czech (QWERTZ)	KBDCTY38	2-7	

Selection	Setting <i>* Indicates default</i>	Serial Command <i># Indicates a numeric entry</i>	Page
	Denmark	KBDCTY8	2-7
	Dutch (Netherlands)	KBDCTY11	2-7
	Estonia	KBDCTY41	2-8
	Faroese	KBDCTY83	2-8
	Finland	KBDCTY2	2-8
	France	KBDCTY3	2-8
	Gaelic	KBDCTY84	2-8
	Germany	KBDCTY4	2-8
	Greek	KBDCTY17	2-8
	Greek (220 Latin)	KBDCTY64	2-8
	Greek (220)	KBDCTY61	2-8
	Greek (319 Latin)	KBDCTY65	2-8
	Greek (319)	KBDCTY62	2-8
	Greek (Latin)	KBDCTY63	2-9
	Greek (MS)	KBDCTY66	2-9
	Greek (Polytonic)	KBDCTY60	2-9
	Hebrew	KBDCTY12	2-9
	Hungarian (101 key)	KBDCTY50	2-9
	Hungary	KBDCTY19	2-9
	Iceland	KBDCTY75	2-9
	Irish	KBDCTY73	2-9
	Italian (142)	KBDCTY56	2-9
	Italy	KBDCTY5	2-9
	Japan ASCII	KBDCTY28	2-9
	Kazakh	KBDCTY78	2-10
	Kyrgyz (Cyrillic)	KBDCTY79	2-10
	Latin America	KBDCTY14	2-10
	Latvia	KBDCTY42	2-10
	Latvia (QWERTY)	KBDCTY43	2-10
	Lithuania	KBDCTY44	2-10
	Lithuania (IBM)	KBDCTY45	2-10
	Macedonia	KBDCTY34	2-10
	Malta	KBDCTY74	2-10
	Mongolian (Cyrillic)	KBDCTY86	2-10
	Norway	KBDCTY9	2-10
	Poland	KBDCTY20	2-11
	Polish (214)	KBDCTY57	2-11
	Polish (Programmers)	KBDCTY58	2-11
	Portugal	KBDCTY13	2-11
	Romania	KBDCTY25	2-11
	Russia	KBDCTY26	2-11
	Russian (MS)	KBDCTY67	2-11
	Russian (Typewriter)	KBDCTY68	2-11

Selection	Setting <i>* Indicates default</i>	Serial Command <i># Indicates a numeric entry</i>	Page
	SCS	KBDCTY21	2-11
	Serbia (Cyrillic)	KBDCTY37	2-11
	Serbia (Latin)	KBDCTY36	2-11
	Slovakia	KBDCTY22	2-12
	Slovakia (QWERTY)	KBDCTY49	2-12
	Slovakia (QWERTZ)	KBDCTY48	2-12
	Slovenia	KBDCTY31	2-12
	Spain	KBDCTY10	2-12
	Spanish variation	KBDCTY51	2-12
	Sweden	KBDCTY23	2-12
	Switzerland (French)	KBDCTY29	2-12
	Switzerland (German)	KBDCTY6	2-12
	Tatar	KBDCTY85	2-12
	Turkey F	KBDCTY27	2-12
	Turkey Q	KBDCTY24	2-13
	Ukrainian	KBDCTY76	2-13
	United Kingdom	KBDCTY7	2-13
	United States (Dvorak right)	KBDCTY89	2-13
	United States (Dvorak left)	KBDCTY88	2-13
	United States (Dvorak)	KBDCTY87	2-13
	United States (International)	KBDCTY30	2-13
	Uzbek (Cyrillic)	KBDCTY77	2-13
Keyboard Conversion	*Keyboard Conversion Off	KBDCNV0	2-14
	Convert all Characters to Upper Case	KBDCNV1	2-14
	Convert all Characters to Lower Case	KBDCNV1	2-14
Keyboard Style	*Regular	KBDSTY0	2-13
	Caps Lock	KBDSTY1	2-13
	Shift Lock	KBDSTY2	2-14
	Automatic Caps Lock	KBDSTY6	2-14
	Emulate External Keyboard	KBDSTY5	2-14
Control Character Output	*Control Character Output Off	KBDNPE0	2-15
	*Control Character Output On	KBDNPE1	2-15
Keyboard Modifiers	*Control + X Off	KBDCAS0	2-15
	DOS Mode Control + X	KBDCAS1	2-15
	Windows Mode Control + X	KBDCAS2	2-15
	Windows Mode Prefix/Suffix Off	KBDCAS3	2-15
	*Turbo Mode Off	KBDTMD0	2-16

Selection	Setting <i>* Indicates default</i>	Serial Command <i># Indicates a numeric entry</i>	Page
	Turbo Mode On	KBDTMD1	2-15
	*Numeric Keypad Off	KBDNPS0	2-16
	Numeric Keypad On	KBDNPS1	2-16
	*Auto Direct Connect Off	KBDADC0	2-16
	Auto Direct Connect On	KBDADC1	2-16
Baud Rate	300 BPS	232BAD0	2-16
	600 BPS	232BAD1	2-16
	1200 BPS	232BAD2	2-16
	2400 BPS	232BAD3	2-17
	4800 BPS	232BAD4	2-17
	9600 BPS	232BAD5	2-17
	19200 BPS	232BAD6	2-17
	38400 BPS	232BAD7	2-17
	57600 BPS	232BAD8	2-17
	*115200 BPS	232BAD9	2-17
Word Length: Data Bits, Stop Bits, and Parity	7 Data, 1 Stop, Parity Even	232WRD3	2-17
	7 Data, 1 Stop, Parity None	232WRD0	2-17
	7 Data, 1 Stop, Parity Odd	232WRD6	2-17
	7 Data, 2 Stop, Parity Even	232WRD4	2-18
	7 Data, 2 Stop, Parity None	232WRD1	2-18
	7 Data, 2 Stop, Parity Odd	232WRD7	2-18
	8 Data, 1 Stop, Parity Even	232WRD5	2-18
	*8 Data, 1 Stop, Parity None	232WRD2	2-18
	8 Data, 1 Stop, Parity Odd	232WRD8	2-18
	8 Data, 1 Stop, Parity Mark		2-18
RS232 Receiver Time-out	Range 0 - 300 seconds	232LPT###	2-18
RS232 Handshaking	*RTS/CTS Off	232CTS0	2-19
	Flow Control, No Timeout	232CTS1	2-19
	Two-Direction Flow Control	232CTS2	2-19
	Flow Control with Timeout	232CTS3	2-19
	RS232 Timeout	232DEL####	2-19
	*XON/XOFF Off	232XON0	2-19
	XON/XOFF On	232XON1	2-19
	*ACK/NAK Off	232ACK0	2-20
	ACK/NAK On	232ACK1	2-20
RS232 Stop Mode	RS232 Stop Mode On	232SDY	2-20
Scanner-Biopic Packet Mode	*Packet Mode Off	232PKT0	2-20
	Packet Mode On	232PKT2	2-20
Scanner-Biopic ACK/NAK Mode	*Biopic ACK/NAK Off	232NAK0	2-21
	Biopic ACK/NAK On	232NAK1	2-21
Scanner-Biopic ACK/NAK Timeout	ACK/NAK Timeout *5100	232DLK####	2-21

Selection	Setting <i>* Indicates default</i>	Serial Command <i># Indicates a numeric entry</i>	Page
Input/Output Selections			
Power Up Beeper	Power Up Beeper Off - Scanner	BEPWRO	3-1
	*Power Up Beeper On - Scanner	BEPWR1	3-1
Beep on BEL Character	Beep on BEL On	BELBEP1	3-1
	*Beep on BEL Off	BELBEP0	3-1
Trigger Click	On	BEPTRG1	3-1
	*Off	BEPTRG0	3-1
Beeper - Good Read	Off	BEPBEP0	3-2
	*On	BEPBEP1	3-2
Beeper Volume - Good Read	Off	BEPLVL0	3-2
	Low	BEPLVL1	3-2
	Medium	BEPLVL2	3-2
	*High	BEPLVL3	3-2
Beeper Pitch - Good Read (Frequency)	Low (1600) (min 400Hz)	BEPFQ11600	3-2
	*Medium 2700)	BEPFQ12700	3-2
	High (4200) (max 9000Hz)	BEPFQ14200	3-3
Beeper Pitch - Error (Frequency)	*Razz (250) (min 200Hz)	BEPFQ2800	3-3
	Medium (3250)	BEPFQ23250	3-3
	High (4200) (max 9000Hz)	BEPFQ24200	3-3
Beeper Duration - Good Read	*Normal Beep	BEPBIP0	3-3
	Short Beep	BEPBIP1	3-3
LED - Good Read	Off	BEPLD0	3-3
	*On	BEPLD1	3-3
Number of Beeps - Error	*1	BEPERR3	3-4
	Range 1 - 9	BEPERR#	3-4
Number of Beeps - Good Read	*1	BEPRPT1	3-4
	Range 1 - 9	BEPRPT#	3-4
Good Read Delay	*No Delay	DLYGRD0	3-4
	Short Delay (500 ms)	DLYGRD500	3-4
	Medium Delay (1000 ms)	DLYGRD1000	3-4
	Long Delay (1500 ms)	DLYGRD1500	3-4
User-Specified Good Read Delay	Range 0 - 30,000 ms	DLYGRD#####	3-4
Manual Trigger Mode	Manual Trigger - Normal	PAPHHF	3-5
LED Illumination - Manual Trigger	Low	PWRNOL50	3-8
	*High	PWRNOL150	3-5
Character Activation Mode	*Off	HSTCEN0	3-5
	On	HSTCEN1	3-5
Activation Character	*12 [DC2]	HSTACH	3-5
End Character Activation After Good Read	*Do Not End	HSTCGD0	3-6
	End	HSTCGD1	3-6
Character Activation Timeout	Range 1-300,000 milliseconds (*30,000 ms)	HSTCDT	3-6
Character Deactivation Mode	*Off	HSTDEN0	3-6

Selection	Setting <i>* Indicates default</i>	Serial Command <i># Indicates a numeric entry</i>	Page
	On	HSTDEN1	3-6
Deactivation Character	*14 [DC4]	HSTDCH	3-7
Serial Trigger Mode	Read Time-Out (0 - 300,000 ms) *30,000	TRGSTO####	3-7
Presentation Mode	Presentation Mode	PAPPST	3-7
Idle Illumination	Off	PWRIDL0	3-8
	*On	PWRIDL50	3-8
Presentation Sensitivity	Range 0-20 (*1)	TRGPMS	3-8
Presentation Centering	On	PDCWIN1	3-10
	*Off	PDCWIN0	3-10
	Top	PDCTOP	3-10
	Bottom	PDCBOT	3-10
	Left	PDCLFT	3-10
	Right	PDCRGT	3-10
CodeGate	*Off	AOSCGD0	3-10
	On	AOSCGD1	3-11
Mobile Phone Read Mode	Hand Held Scanning - Mobile Phone	PAPPHC	3-11
	Presentation Scanning - Mobile Phone	PAPPSC	3-11
Poor Quality 1D Codes	On	DECLDI1	3-11
	*Off	DECLDI0	3-11
Poor Quality PDF Codes	On	PDFPR1	3-11
	*Off	PDFXPR0	3-12
Hands Free Time-Out	Range 0 - 300,000 ms	TRGPTO#####	3-12
Reread Delay	Short (500 ms)	DLYRRD500	3-12
	*Medium (750 ms)	DLYRRD750	3-12
	Long (1000 ms)	DLYRRD1000	3-12
	Extra Long (2000 ms)	DLYRRD2000	3-12
User-Specified Reread Delay	Range 0 - 30,000 ms	DLYRRD#####	3-12
2D Reread Delay	*2D Reread Delay Off	DLY2RR0	3-13
	Short (1000ms)	DLY2RR1000	3-13
	Medium (2000ms)	DLY2RR2000	3-13
	Long (3000ms)	DLY2RR3000	3-13
	Extra Long (4000ms)	DLY2RR4000	3-13
Illumination Lights	*Lights On	SCNLED1	3-13
	Lights Off	SCNLED0	3-13
Aimer Delay	200 milliseconds	SCNDLY200	3-14
	400 milliseconds	SCNDLY400	3-14
	*Off (no delay)	SCNDLY0	3-14
User-Specified Aimer Delay	Range 0 - 4,000 ms	SCNDLY####	3-14
Aimer Mode	Off	SCNAIM0	3-14
	*Interlaced	SCNAIM2	3-14
	Interlaced Optimized for Decode	SCNAIM4	3-14

Selection	Setting <i>* Indicates default</i>	Serial Command <i># Indicates a numeric entry</i>	Page
Centering Window	Centering On	DECWIN1	3-15
	*Centering Off	DECWIN0	3-15
	Top of Centering Window (*40%)	DECTOP###	3-16
	Bottom of Centering Window (*60%)	DECBOT###	3-16
Output Sequence Editor	Enter Sequence	SEQBLK	3-18
	Default Sequence	SEQDFT	3-18
Partial Sequence	Transmit Partial Sequence	SEQTTS1	3-18
	*Discard Partial Sequence	SEQTTS0	3-18
Require Output Sequence	Required	SEQ_EN2	3-18
	On/Not Required	SEQ_EN1	3-18
	*Off	SEQ_EN0	3-18
Multiple Symbols	On	SHOTGN1	3-19
	*Off	SHOTGN0	3-19
No Read	On	SHWNRD1	3-16
	*Off	SHWNRD0	3-16
Video Reverse	Video Reverse Only	VIDREV1	3-19
	Video Reverse and Standard Bar Codes	VIDREV2	3-19
	*Video Reverse Off	VIDREV0	3-19
Working Orientation	*Upright	ROTATN0	3-20
	Vertical, Bottom to Top (Rotate CCW 90°)	ROTATN1	3-20
	Upside Down	ROTATN2	3-20
	Vertical, Top to Bottom (Rotate CW 90°)	ROTATN3	3-20
Prefix/Suffix Selections			
Add CR Suffix to All Symbologies		VSUFCR	4-2
Prefix	Add Prefix	PREBK2##	4-2
	Clear One Prefix	PRECL2	4-2
	Clear All Prefixes	PRECA2	4-2
Suffix	Add Suffix	SUFBK2##	4-2
	Clear One Suffix	SUFCL2	4-3
	Clear All Suffixes	SUFCA2	4-3
Function Code Transmit	*Enable	RMVFNC0	4-3
	Disable	RMVFNC1	4-3
Intercharacter Delay	Range 0 - 1000 (5ms increments)	DLYCHR##	4-3
User Specified Intercharacter Delay	Delay Length 0 - 1000 (5ms increments)	DLYCRX##	4-3
	Character to Trigger Delay	DLY_XX##	4-3
Interfunction Delay	Range 0 - 1000 (5ms increments)	DLYFNC##	4-4
Intermessage Delay	Range 0 - 1000 (5ms increments)	DLYMSG##	4-4
Data Formatter Selections			
Data Format Editor	*Default Data Format (None)	DFMDF3	5-1
	Enter Data Format	DFMBK3##	5-2
	Clear One Data Format	DFMCL3	5-2
	Clear All Data Formats	DFMCA3	5-2

Selection	Setting <i>* Indicates default</i>	Serial Command <i># Indicates a numeric entry</i>	Page
Data Formatter	Data Formatter Off	DFM_EN0	5-9
	*Data Formatter On, Not Required, Keep Prefix/Suffix	DFM_EN1	5-9
	Data Format Required, Keep Prefix/Suffix	DFM_EN2	5-9
	Data Formatter On, Not Required, Drop Prefix/Suffix	DFM_EN3	5-9
	Data Format Required, Drop Prefix/Suffix	DFM_EN4	5-9
Primary/Alternate Data Formats	Primary Data Format	ALTFNM0	5-10
	Data Format 1	ALTFNM1	5-10
	Data Format 2	ALTFNM2	5-10
	Data Format 3	ALTFNM3	5-10
Symbologies			
All Symbologies	All Symbologies Off	ALLENA0	6-1
	All Symbologies On	ALLENA1	6-1
Codabar	Default All Codabar Settings	CBRDFT	6-2
	Off	CBRENA0	6-2
	*On	CBRENA1	6-2
Codabar Start/Stop Char.	*Don't Transmit	CBRSSX0	6-2
	Transmit	CBRSSX1	6-2
Codabar Check Char.	*No Check Character	CBRCK20	6-2
	Validate Modulo 16, But Don't Transmit	CBRCK21	6-3
	Validate Modulo 16, and Transmit	CBRCK22	6-3
Codabar Concatenation	*Off	CBRCCT0	6-3
	On	CBRCCT1	6-3
	Require	CBRCCT2	6-3
Codabar Message Length	Minimum (2 - 60) *4	CBRMIN##	6-3
	Maximum (2 - 60) *60	CBRMAX##	6-3
Code 39	Default All Code 39 Settings	C39DFT	6-4
	Off	C39ENA0	6-4
	*On	C39ENA1	6-4
Code 39 Start/Stop Char.	*Don't Transmit	C39SSX0	6-4
	Transmit	C39SSX1	6-4
Code 39 Check Char.	*No Check Char.	C39CK20	6-4
	Validate, But Don't Transmit	C39CK21	6-4
	Validate, and Transmit	C39CK22	6-4
Code 39 Message Length	Minimum (0 - 48) *0	C39MIN##	6-5
	Maximum (0 - 48) *48	C39MAX##	6-5

Selection	Setting <i>* Indicates default</i>	Serial Command <i># Indicates a numeric entry</i>	Page
Code 39 Append	*Off	C39APP0	6-5
	On	C39APP1	6-5
Code 32 Pharmaceutical (PARAF)	*Off	C39B320	6-5
	On	C39B321	6-5
Code 39 Full ASCII	*Off	C39ASC0	6-6
	On	C39ASC1	6-6
	Code 39 Code Page	C39DCP	6-6
Interleaved 2 of 5	Default All Interleaved 2 of 5 Settings	I25DFT	6-7
	Off	I25ENA0	6-7
	*On	I25ENA1	6-7
Interleaved 2 of 5 Check Digit	*No Check Char.	I25CK20	6-7
	Validate, But Don't Transmit	I25CK21	6-7
	Validate, and Transmit	I25CK22	6-7
Interleaved 2 of 5 Message Length	Minimum (2 - 80) *4	I25MIN##	6-7
	Maximum (2 - 80) *80	I25MAX##	6-7
NEC 2 of 5	Default All NEC 2 of 5 Settings	N25DFT	6-8
	Off	N25ENA0	6-8
	*On	N25ENA1	6-8
NEC 2 of 5 Check Digit	*No Check Char.	N25CK20	6-8
	Validate, But Don't Transmit	N25CK21	6-8
	Validate, and Transmit	N25CK22	6-8
NEC 2 of 5 Message Length	Minimum (2 - 80) *4	N25MIN##	6-9
	Maximum (2 - 80) *80	N25MAX##	6-9
Code 93	Default All Code 93 Settings	C93DFT	6-9
	Off	C93ENA0	6-9
	*On	C93ENA1	6-9
Code 93 Message Length	Minimum (0 - 80) *0	C93MIN##	6-9
	Maximum (0 - 80) *80	C93MAX##	6-9
Code 93 Append	On	C93APP1	6-10
	*Off	C93APP0	6-10
Code 93 Code Page	Code 93 Code Page	C93DCP	6-10
Straight 2 of 5 Industrial	Default All Straight 2 of 5 Industrial Settings	R25DFT	6-11
	*Off	R25ENA0	6-11
	On	R25ENA1	6-11
Straight 2 of 5 Industrial Message Length	Minimum (1 - 48) *4	R25MIN##	6-11
	Maximum (1 - 48) *48	R25MAX##	6-11

Selection	Setting <i>* Indicates default</i>	Serial Command <i># Indicates a numeric entry</i>	Page
Straight 2 of 5 IATA	Default All Straight 2 of 5 IATA Settings	A25DFT	6-12
	*Off	A25ENA0	6-12
	On	A25ENA1	6-12
Straight 2 of 5 IATA Message Length	Minimum (1 - 48) *4	A25MIN##	6-12
	Maximum (1 - 48) *48	A25MAX##	6-12
Matrix 2 of 5	Default All Matrix 2 of 5 Settings	X25DFT	6-13
	*Off	X25ENA0	6-13
	On	X25ENA1	6-13
Matrix 2 of 5 Message Length	Minimum (1 - 80) *4	X25MIN##	6-13
	Maximum (1 - 80) *80	X25MAX##	6-13
Code 11	Default All Code 11 Settings	C11DFT	6-14
	*Off	C11ENA0	6-14
	On	C11ENA1	6-14
Code 11 Check Digits Required	1 Check Digit	C11CK20	6-14
	*2 Check Digits	C11CK21	6-14
Code 11 Message Length	Minimum (1 - 80) *4	C11MIN##	6-14
	Maximum (1 - 80) *80	C11MAX##	6-14
Code 128	Default All Code 128 Settings	128DFT	6-15
	Off	128ENA0	6-15
	*On	128ENA1	6-15
ISBT Concatenation	*Off	ISBENA0	6-15
	On	ISBENA1	6-15
Code 128 Message Length	Minimum (0 - 80) *0	128MIN##	6-15
	Maximum (0 - 90) *80	128MAX##	6-15
Code 128 Append	*On	128APP1	6-16
	Off	128APP0	6-16
Code 128 Code Page	Code 128 Code Page (*2)	128DCP##	6-16
GS1-128	Default All GS1-128 Settings	GS1DFT	6-17
	*On	GS1ENA1	6-17
	Off	GS1ENA0	6-17
GS1-128 Message Length	Minimum (1 - 80) *1	GS1MIN	6-17
	Maximum (0 - 80) *80	GS1MAX	6-17
UPC-A	Default All UPC-A Settings	UPADFT	6-17
	Off	UPBENA0	6-17
	*On	UPBENA1	6-17
UPC-A Check Digit	Off	UPACKX0	6-18
	*On	UPACKX1	6-18
UPC-A Number System	Off	UPANSX0	6-18
	*On	UPANSX1	6-18

Selection	Setting <i>* Indicates default</i>	Serial Command <i># Indicates a numeric entry</i>	Page
UPC-A 2 Digit Addenda	*Off	UPAAD20	6-18
	On	UPAAD21	6-18
UPC-A 5 Digit Addenda	*Off	UPAAD50	6-18
	On	UPAAD51	6-18
UPC-A Addenda Required	*Not Required	UPAARQ0	6-19
	Required	UPAARQ1	6-19
UPC-A Addenda Separator	Off	UPAADS0	6-19
	*On	UPAADS1	6-19
UPC-A/EAN-13 with Extended Coupon Code	*Off	CPNENA0	6-19
	Allow Concatenation	CPNENA1	6-19
	Require Concatenation	CPNENA2	6-19
Coupon GS1 DataBar Output	GS1 Output Off	CPNGS10	6-20
	GS1 Output On	CPNGS11	6-20
UPC-E0	Default All UPC-E Settings	UPEDFT	6-20
	Off	UPEEN00	6-20
	*On	UPEEN01	6-20
UPC-E0 Expand	*Off	UPEEXP0	6-20
	On	UPEEXP1	6-20
UPC-E0 Addenda Required	Required	UPEARQ1	6-21
	*Not Required	UPEARQ0	6-21
UPC-E0 Addenda Separator	*On	UPEADS1	6-21
	Off	UPEADS0	6-21
UPC-E0 Check Digit	Off	UPECKX0	6-21
	*On	UPECKX1	6-21
UPC-E0 Leading Zero	Off	UPENSX0	6-21
	*On	UPENSX1	6-21
UPC-E0 Addenda	2 Digit Addenda On	UPEAD21	6-22
	*2 Digit Addenda Off	UPEAD20	6-22
	5 Digit Addenda On	UPEAD51	6-22
	*5 Digit Addenda Off	UPEAD50	6-22
UPC-E1	*Off	UPEEN10	6-22
	On	UPEEN11	6-22
EAN/JAN-13	Default All EAN/JAN Settings	E13DFT	6-23
	Off	E13ENA0	6-23
	*On	E13ENA1	6-23
Convert UPC-A to EAN-13	UPC-A Converted to EAN-13	UPAENA0	6-23
	Do not Convert UPC-A	UPAENA1	6-23
EAN/JAN-13 Check Digit	Off	E13CKX0	6-23
	*On	E13CKX1	6-23

Selection	Setting <i>* Indicates default</i>	Serial Command <i># Indicates a numeric entry</i>	Page
EAN/JAN-13 2 Digit Addenda	2 Digit Addenda On	E13AD21	6-24
	*2 Digit Addenda Off	E13AD20	6-24
	5 Digit Addenda On	E13AD51	6-24
	*5 Digit Addenda Off	E13AD50	6-24
EAN/JAN-13 Addenda Required	*Not Required	E13ARQ0	6-24
	Required	E13ARQ1	6-24
EAN/JAN-13 Addenda Separator	Off	E13ADS0	6-24
	*On	E13ADS1	6-24
ISBN Translate	*Off	E13ISB0	6-25
	On	E13ISB1	6-25
EAN/JAN-8	Default All EAN/ JAN 8 Settings	EA8DFT	6-25
	Off	EA8ENA0	6-25
	*On	EA8ENA1	6-25
EAN/JAN-8 Check Digit	Off	EA8CKX0	6-25
	*On	EA8CKX1	6-25
EAN/JAN-8 Addenda	*2 Digit Addenda Off	EA8AD20	6-26
	2 Digit Addenda On	EA8AD21	6-26
	5 Digit Addenda On	EA8AD51	6-26
	*5 Digit Addenda Off	EA8AD50	6-26
EAN/JAN-8 Addenda Required	*Not Required	EA8ARQ0	6-26
	Required	EA8ARQ1	6-26
EAN/JAN-8 Addenda Separator	Off	EA8ADS0	6-26
	*On	EA8ADS1	6-26
MSI	Default All MSI Settings	MSIDFT	6-27
	*Off	MSIENA0	6-27
	On	MSIENA1	6-27
MSI Check Character	*Validate Type 10, but Don't Transmit	MSICHK0	6-27
	Validate Type 10 and Transmit	MSICHK1	6-27
	Validate 2 Type 10 Chars, but Don't Transmit	MSICHK2	6-27
	Validate 2 Type 10 Chars and Transmit	MSICHK3	6-27
	Validate Type 11 then Type 10 Char, but Don't Transmit	MSICHK4	6-27
	Validate Type 11 then Type 10 Char and Transmit	MSICHK5	6-28
	Disable MSI Check Characters	MSICHK6	6-28
MSI Message Length	Minimum (4 - 48) *4	MSIMIN##	6-28
	Maximum (4 - 48) *48	MSIMAX##	6-28
GS1 DataBar Omnidirectional	Default All GS1 DataBar Omnidirectional Settings	RSSDFT	6-29
	Off	RSSENA0	6-29
	*On	RSSENA1	6-29

Selection	Setting <i>* Indicates default</i>	Serial Command <i># Indicates a numeric entry</i>	Page
GS1 DataBar Limited	Default All GS1 DataBar Limited Settings	RSLDFT	6-29
	Off	RSLENA0	6-29
	*On	RSLENA1	6-29
GS1 DataBar Expanded	Default All GS1 DataBar Expanded Settings	RSEDFT	6-30
	Off	RSEENA0	6-30
	*On	RSEENA1	6-30
GS1 DataBar Expanded Msg. Length	Minimum (4 - 74) *4	RSEMIN##	6-30
	Maximum (4 - 74) *74	RSEMAX##	6-30
Trioptic Code	*Off	TRIENA0	6-30
	On	TRIENA1	6-30
Codablock A	Default All Codablock A Settings	CBADFT	6-30
	*Off	CBAENA0	6-30
	On	CBAENA1	6-30
Codablock A Msg. Length	Minimum (1 - 600) *1	CBAMIN####	6-31
	Maximum (1 - 600) *600	CBAMAX####	6-31
Codablock F	Default All Codablock F Settings	CBFDFT	6-31
	*Off	CBFENA0	6-31
	On	CBFENA1	6-31
Codablock F Msg. Length	Minimum (1 - 2048) *1	CBFMIN####	6-31
	Maximum (1 - 2048) *2048	CBFMAX####	6-31
PDF417	Default All PDF417 Settings	PDFDFT	6-32
	*On	PDFENA1	6-32
	Off	PDFENA0	6-32
PDF417 Msg. Length	Minimum (1-2750) *1	PDFMIN	6-32
	Maximum (1-2750) *2750	PDFMAX	6-32
MacroPDF417	*On	PDFMAC1	6-32
	Off	PDFMAC0	6-32
MicroPDF417	Default All Micro PDF417 Settings	MPDDFT	6-33
	On	MPDENA1	6-33
	*Off	MPDENA0	6-33
MicroPDF417 Msg. Length	Minimum (1-366) *1	MPDMIN	6-33
	Maximum (1-366) *366	MPDMAX	6-33
GS1 Composite Codes	On	COMENA1	6-33
	*Off	COMENA0	6-33
UPC/EAN Version	On	COMUPC1	6-34
	*Off	COMUPC0	6-34
GS1 Composite Codes Msg. Length	Minimum (1-2435) *1	COMMIN	6-34
	Maximum (1-2435) *2435	COMMAX	6-34

Selection	Setting <i>* Indicates default</i>	Serial Command <i># Indicates a numeric entry</i>	Page
GS1 Emulation	GS1-128 Emulation	EANEMU1	6-34
	GS1 DataBar Emulation	EANEMU2	6-35
	GS1 Code Expansion Off	EANEMU3	6-35
	EAN8 to EAN13 Conversion	EANEMU4	6-35
	*GS1 Emulation Off	EANEMU0	6-35
TCIF Linked Code 39	On	T39ENA1	6-35
	*Off	T39ENA0	6-35
QR Code	Default All QR Code Settings	QRCDFT	6-35
	*On	QRCENA1	6-35
	Off	QRCENA0	6-35
QR Code Msg. Length	Minimum (1-7089) *1	QRCPMIN	6-36
	Maximum (1-7089) *7089	QRCPMAX	6-36
QR Code Append	*On	QRCAPP1	6-36
	Off	QRCAPP0	6-36
QR Code Page	QR Code Page (*3)	QRCDCP##	6-36
Data Matrix	Default All Data Matrix Settings	IDMDFT	6-37
	*On	IDMENA1	6-37
	Off	IDMENA0	6-37
Data Matrix Msg. Length	Minimum (1-3116) *1	IDMMIN	6-37
	Maximum (1-3116) *3116	IDMMAX	6-37
Data Matrix Append	*On	IDMAPP1	6-37
	Off	IDMAPP0	6-37
Data Matrix Code Page	Data Matrix Code Page (*51)	IDMDCP##	6-37
MaxiCode	Default All MaxiCode Settings	MAXDFT	6-38
	*On	MAXENA1	6-38
	Off	MAXENA0	6-38
MaxiCode Msg. Length	Minimum (1-150) *1	MAXMIN	6-38
	Maximum (1-150) *150	MAXMAX	6-38
Aztec Code	Default All Aztec Code Settings	AZTDFT	6-39
	*On	AZTENA1	6-39
	Off	AZTENA0	6-39
Aztec Code Msg. Length	Minimum (1-3832) *1	AZTMIN	6-39
	Maximum (1-3832) *3832	AZTMAX	6-39
Aztec Append	*On	AZTAPP1	6-39
	Off	AZTAPP0	6-39
Aztec Code Page	Aztec Code Page (*51)	AZTDCP##	6-39
Chinese Sensible (Han Xin) Code	Default All Han Xin Code Settings	HX_DFT	6-40
	On	HX_ENA1	6-40
	*Off	HX_ENA0	6-40
Chinese Sensible (Han Xin) Code Msg. Length	Minimum (1-7833) *1	HX_MIN	6-40
	Maximum (1-7833) *7833	HX_MAX	6-40
Postal Codes - 2D			
2D Postal Codes	*Off	POSTAL0	6-41

Selection	Setting <i>* Indicates default</i>	Serial Command <i># Indicates a numeric entry</i>	Page
Single 2D Postal Codes	Australian Post On	POSTAL1	6-41
	British Post On	POSTAL7	6-41
	Canadian Post On	POSTAL30	6-41
	Intelligent Mail Bar Code On	POSTAL10	6-41
	Japanese Post On	POSTAL3	6-41
	KIX Post On	POSTAL4	6-41
	Planet Code On	POSTAL5	6-41
	Postal-4i On	POSTAL9	6-41
	Postnet On	POSTAL6	6-42
	Postnet with B and B' Fields On	POSTAL11	6-42
	InfoMail On	POSTAL2	6-42
Combination 2D Postal Codes	InfoMail and British Post On	POSTAL8	6-42
	Intelligent Mail Bar Code and Postnet with B and B' Fields On	POSTAL20	6-42
	Postnet and Postal-4i On	POSTAL14	6-42
	Postnet and Intelligent Mail Bar Code On	POSTAL16	6-42
	Postal-4i and Intelligent Mail Bar Code On	POSTAL17	6-42
	Postal-4i and Postnet with B and B' Fields On	POSTAL19	6-42
	Planet and Postnet On	POSTAL12	6-42
	Planet and Postnet with B and B' Fields On	POSTAL18	6-43
	Planet and Postal-4i On	POSTAL13	6-43
	Planet and Intelligent Mail Bar Code On	POSTAL15	6-43
	Planet, Postnet, and Postal-4i On	POSTAL21	6-43
	Planet, Postnet, and Intelligent Mail Bar Code On	POSTAL22	6-43
	Planet, Postal-4i, and Intelligent Mail Bar Code On	POSTAL23	6-43
	Postnet, Postal-4i, and Intelligent Mail Bar Code On	POSTAL24	6-43
	Planet, Postal-4i, and Postnet with B and B' Fields On	POSTAL25	6-43
	Planet, Intelligent Mail Bar Code, and Postnet with B and B' Fields On	POSTAL26	6-43
	Postal-4i, Intelligent Mail Bar Code, and Postnet with B and B' Fields On	POSTAL27	6-43
	Planet, Postal-4i, Intelligent Mail Bar Code, and Postnet On	POSTAL28	6-44
	Planet, Postal-4i, Intelligent Mail Bar Code, and Postnet with B and B' Fields On	POSTAL29	6-44
	Planet Code Check Digit	Transmit	PLNCKX1
*Don't Transmit		PLNCKX0	6-44

Selection	Setting <i>* Indicates default</i>	Serial Command <i># Indicates a numeric entry</i>	Page
Postnet Check Digit	Transmit	NETCKX1	6-44
	*Don't Transmit	NETCKX0	6-44
Australian Post Interpretation	Bar Output	AUSINT0	6-45
	Numeric N Table	AUSINT1	6-45
	Alphanumeric C Table	AUSINT2	6-45
	Combination N and C Tables	AUSINT3	6-45
Postal Codes - Linear			
China Post (Hong Kong 2 of 5)	Default All China Post (Hong Kong 2 of 5) Settings	CPCDFT	6-45
	*Off	CPCENA0	6-45
	On	CPCENA1	6-45
China Post (Hong Kong 2 of 5) Msg. Length	Minimum (2 - 80) *4	CPCMIN##	6-45
	Maximum (2 - 80) *80	CPCMAX##	6-45
Korea Post	Default All Korea Post Settings	KPCDFT	6-46
	*Off	KPCENA0	6-46
	On	KPCENA1	6-46
Korea Post Msg. Length	Minimum (2 - 80) *4	KPCMIN##	6-46
	Maximum (2 - 80) *48	KPCMAX##	6-46
Korea Post Check Digit	Transmit Check Digit	KPCCHK1	6-46
	*Don't Transmit Check Digit	KPCCHK0	6-46
Imaging Default Commands			
Image Snap	Default all Imaging Commands	IMGDFT	7-1
	Imaging Style - Decoding	SNPSTY0	7-1
	*Imaging Style - Photo	SNPSTY1	7-1
	Imaging Style - Manual	SNPSTY2	7-1
	Beeper On	SNPBEP1	7-1
	*Beeper Off	SNPBEP0	7-1
	*Wait for Trigger Off	SNPTRG0	7-2
	Wait for Trigger On	SNPTRG1	7-2
	*LED State - Off	SNPLED0	7-2
	LED State - On	SNPLED1	7-2
	Exposure (1-7874 microseconds)	SNPEXP	7-2
	*Gain - None	SNPGAN1	7-2
	Gain - Medium	SNPGAN2	7-2
	Gain - Heavy	SNPGAN4	7-2
	Gain - Maximum	SNPGAN8	7-2
	Target White Value (0-255) *125	SNPWHT###	7-3
	Delta for Acceptance (0-255) *25	SNPDEL###	7-3
	Update Tries (0-10) *6	SNPTRY##	7-3
	Target Set Point Percentage (1-99) *50	SNPPCT##	7-3
	Image Ship	*Infinity Filter - Off	IMGINF0
Infinity Filter - On		IMGINF1	7-3

Selection	Setting <i>* Indicates default</i>	Serial Command <i># Indicates a numeric entry</i>	Page
	*Compensation Off	IMGCOR0	7-4
	Compensation On	IMGCOR1	7-4
	*Pixel Depth - 8 bits/pixel (grayscale)	IMGBPP8	7-4
	Pixel Depth - 1 bit/pixel (B&W)	IMGBPP1	7-4
	*Don't Sharpen Edges	IMGEDG0	7-5
	Sharpen Edges (0-23)	IMGEDG##	7-5
	*File Format - JPEG	IMGFMT6	7-5
	File Format - KIM	IMGFMT0	7-5
	File Format - TIFF binary	IMGFMT1	7-5
	File Format - TIFF binary group 4, compressed	IMGFMT2	7-5
	File Format - TIFF grayscale	IMGFMT3	7-5
	File Format - Uncompressed binary	IMGFMT4	7-5
	File Format - Uncompressed grayscale	IMGFMT5	7-5
	File Format - BMP	IMGFMT8	7-5
	*Histogram Stretch Off	IMGHIS0	7-5
	Histogram Stretch On	IMGHIS1	7-5
	*Noise Reduction Off	IMGFSP0	7-6
	Noise Reduction On	IMGFSP1	7-6
	Invert Image around X axis	IMGNVX1	7-5
	Invert Image around Y axis	IMGNVY1	7-5
	Rotate Image none	IMGROT0	7-7
	Rotate Image 90° right	IMGROT1	7-7
	Rotate Image 180° right	IMGROT2	7-7
	Rotate Image 90° left	IMGROT3	7-7
	JPEG Image Quality (0-100) *50	IMGJQF###	7-7
	*Gamma Correction Off	IMGGAM0	7-7
	Gamma Correction On (0-1000)	IMGGAM###	7-7
	Image Crop - Left (0-640) *0	IMGWNL###	7-7
	Image Crop - Right (0-640) *639	IMGWNR###	7-7
	Image Crop - Top (0-480) *0	IMGWNT###	7-7
	Image Crop - Bottom (0-480) *479	IMGWNB###	7-7
	Image Crop - Margin (1-238) *0	IMGMAR###	7-7
	Protocol - None (raw)	IMGXFR0	7-8
	Protocol - None (default USB)	IMGXFR2	7-8
	Protocol - Hmodem Compressed	IMGXFR3	7-8
	Protocol - Hmodem	IMGXFR4	7-8
	Ship Every Pixel	IMGSUB1	7-8
	Ship Every 2nd Pixel	IMGSUB2	7-8
	Ship Every 3rd Pixel	IMGSUB3	7-8
	*Document Image Filter Off	IMGUSH0	7-9
	Document Image Filter On (0-255)	IMGUSH###	7-9
	*Don't Ship Histogram	IMGHST0	7-9

Selection	Setting <i>* Indicates default</i>	Serial Command <i># Indicates a numeric entry</i>	Page
	Ship Histogram	IMGHST1	7-9
Utilities			
Add Code I.D. Prefix to All Symbologies (Temporary)		PRECA2,BK2995C80!	8-1
Show Decoder Revision		REV_DR	8-1
Show Scan Driver Revision		REV_SD	8-1
Show Software Revision		REVINF	8-1
Show Data Format		DFMBK3?	8-1
Test Menu	On	TSTMNU1	8-2
	*Off	TSTMNU0	8-2
Resetting the Factory Defaults	Remove Custom Defaults	DEFOVR	8-3
	Activate Defaults	DEFALT	8-3



Maintenance and Troubleshooting

Repairs

Repairs and/or upgrades are not to be performed on this product. These services are to be performed only by an authorized service center. See ["Contact Customer Support" on page vii](#) for further information.

Inspecting Cords and Connectors

Inspect the scan engine's interface cable and connector for wear or other signs of damage. A badly worn cable or damaged connector may interfere with scan engine operation. Contact your Honeywell distributor for information about cable replacement.

Troubleshooting

The scan engine automatically performs self-tests whenever you turn it on. If your scan engine is not functioning properly, review the following Troubleshooting Guide to try to isolate the problem.

Is the power on? Is the red or green aiming illumination line on?

If the aiming line doesn't appear, check that:

- The cable is connected properly.
- The host system power is on (if external power isn't used).

Is the scan engine having trouble reading your symbols?

If the scan engine isn't reading symbols well, check that the symbols:

- Aren't smeared, rough, scratched, or exhibiting voids.
- Aren't coated with frost or water droplets on the surface.
- Are enabled in the scan engine or in the decoder to which the scan engine connects.

Is the bar code displayed but not entered?

The bar code is displayed on the host device correctly, but you still have to press a key to enter it (the Enter/Return key or the Tab key, for example).

You need to program a suffix. Programming a suffix enables the scan engine to output the bar code data plus the key you need (such as "CR") to enter the data into your application. Refer to "Prefix/Suffix Overview" on page 4-1 for further information.

Does the scan engine read the bar code incorrectly?

If the scan engine reads a bar code, but the data is not displayed correctly on the host screen:

- The scan engine may not be programmed for the appropriate terminal interface.
For example, you scan "12345" and the host displays "@es%."

Reprogram the scan engine with the correct Plug and Play or Terminal selection bar code. See [Chapter 2](#) and [Chapter 3](#).

The scan engine may not be programmed to output your bar code data properly.
For example, you scan "12345" and the host displays "A12345B."

Reprogram the scan engine with the proper symbology selections. See [Chapter 6](#).

The scan engine won't read your bar code at all.

1. Scan the sample bar codes in the back of this manual. If the scan engine reads the sample bar codes, check that your bar code is readable.
Verify that your bar code symbology is enabled (see [Chapter 6](#)).
2. If the scan engine still can't read the sample bar codes, scan ["All Symbologies" on page 6-1](#).

If you aren't sure what programming options have been set in the scan engine, or if you want the factory default settings restored, scan [Resetting the Factory Defaults](#) on page 8-3.



Reference Charts

Symbology Charts

Note: “m” represents the AIM modifier character. Refer to *International Technical Specification, Symbology Identifiers*, for AIM modifier character details.

Prefix/Suffix entries for specific symbologies override the universal (*All Symbologies*, 99) entry.

Refer to [Data Editing](#) beginning on page 4-1 and [Data Formatting](#) beginning on page 5-1 for information about using Code ID and AIM ID.

Linear Symbologies

Symbology	AIM		Honeywell	
	ID	Possible modifiers (m)	ID	Hex
<i>All Symbologies</i>				99
Codabar]Fm	0-1	a	61
Code 11]H3		h	68
Code 128]Cm	0, 1, 2, 4	j	6A
Code 32 Pharmaceutical (PARAF)]X0		<	3C
Code 39 (supports Full ASCII mode)]Am	0, 1, 3, 4, 5, 7	b	62
TCIF Linked Code 39 (TLC39)]L2		T	54
Code 93 and 93i]Gm	0-9, A-Z, a-m	i	69
EAN]Em	0, 1, 3, 4	d	64
EAN-13 (including Bookland EAN)]E0		d	64
EAN-13 with Add-On]E3		d	64
EAN-13 with Extended Coupon Code]E3		d	64
EAN-8]E4		D	44
EAN-8 with Add-On]E3		D	44
GS1				
GS1 DataBar]em	0	y	79
GS1 DataBar Limited]em		{	7B
GS1 DataBar Expanded]em		}	7D
GS1-128]C1		l	49
2 of 5				
China Post (Hong Kong 2 of 5)]X0		Q	51
Interleaved 2 of 5]Im	0, 1, 3	e	65
Matrix 2 of 5]X0		m	6D
NEC 2 of 5]X0		Y	59
Straight 2 of 5 IATA]Rm	0, 1, 3	f	66
Straight 2 of 5 Industrial]S0		f	66
MSI]Mm	0, 1	g	67
Telepen]Bm		t	74
UPC		0, 1, 2, 3, 8, 9, A, B, C		

Symbology	AIM		Honeywell	
	ID	Possible modifiers (<i>m</i>)	ID	Hex
UPC-A]E0		c	63
UPC-A with Add-On]E3		c	63
UPC-A with Extended Coupon Code]E3		c	63
UPC-E]E0		E	45
UPC-E with Add-On]E3		E	45
UPC-E1]X0		E	45
Add Honeywell Code ID				5C80
Add AIM Code ID				5C81
Add Backslash				5C5C
Batch mode quantity			5	35

2D Symbologies

Symbology	AIM		Honeywell	
	ID	Possible modifiers (m)	ID	Hex
<i>All Symbologies</i>				99
Aztec Code]zm	0-9, A-C	z	7A
Chinese Sensible Code (Han Xin Code)]X0		H	48
Codablock A]O6	0, 1, 4, 5, 6	V	56
Codablock F]Om	0, 1, 4, 5, 6	q	71
Code 49]Tm	0, 1, 2, 4	l	6C
Data Matrix]dm	0-6	w	77
GS1]em	0-3	y	79
GS1 Composite]em	0-3	y	79
GS1 DataBar Omnidirectional]em		y	79
MaxiCode]Um	0-3	x	78
PDF417]Lm	0-2	r	72
MicroPDF417]Lm	0-5	R	52
QR Code]Qm	0-6	s	73
Micro QR Code]Qm		s	73

Postal Symbologies

Symbology	AIM		Honeywell	
	ID	Possible modifiers (m)	ID	Hex
<i>All Symbologies</i>				99
Australian Post]X0		A	41
British Post]X0		B	42
Canadian Post]X0		C	43
China Post]X0		Q	51
InfoMail]X0		,	2c
Intelligent Mail Bar Code]X0		M	4D
Japanese Post]X0		J	4A
KIX (Netherlands) Post]X0		K	4B
Korea Post]X0		?	3F
Planet Code]X0		L	4C
Postal-4i]X0		N	4E
Postnet]X0		P	50

ASCII Conversion Chart (Code Page 1252)

In keyboard applications, ASCII Control Characters can be represented in 3 different ways, as shown below. The CTRL+X function is OS and application dependent. The following table lists some commonly used Microsoft functionality. This table applies to

U.S. style keyboards. Certain characters may differ depending on your Country Code/PC regional settings.

Non-printable ASCII control characters			Keyboard Control + ASCII (CTRL+X) Mode		
DEC	HEX	Char	Control + X Mode Off (KBDCAS0)	Windows Mode Control + X Mode On (KBDCAS2)	
DEC	HEX	Char	Control + X Mode Off (KBDCAS0)	CTRL + X	CTRL + X function
0	00	NUL	Reserved	CTRL+ @	
1	01	SOH	NP Enter	CTRL+ A	Select all
2	02	STX	Caps Lock	CTRL+ B	Bold
3	03	ETX	ALT Make	CTRL+ C	Copy
4	04	EOT	ALT Break	CTRL+ D	Bookmark
5	05	ENQ	CTRL Make	CTRL+ E	Center
6	06	ACK	CTRL Break	CTRL+ F	Find
7	07	BEL	Enter / Ret	CTRL+ G	
8	08	BS	(Apple Make)	CTRL+ H	History
9	09	HT	Tab	CTRL+ I	Italic
10	0A	LF	(Apple Break)	CTRL+ J	Justify
11	0B	VT	Tab	CTRL+ K	hyperlink
12	0C	FF	Delete	CTRL+ L	list, left align
13	0D	CR	Enter / Ret	CTRL+ M	
14	0E	SO	Insert	CTRL+ N	New
15	0F	SI	ESC	CTRL+ O	Open
16	10	DLE	F11	CTRL+ P	Print
17	11	DC1	Home	CTRL+ Q	Quit
18	12	DC2	PrtScn	CTRL+ R	
19	13	DC3	Backspace	CTRL+ S	Save
20	14	DC4	Back Tab	CTRL+ T	
21	15	NAK	F12	CTRL+ U	
22	16	SYN	F1	CTRL+ V	Paste
23	17	ETB	F2	CTRL+ W	
24	18	CAN	F3	CTRL+ X	
25	19	EM	F4	CTRL+ Y	
26	1A	SUB	F5	CTRL+ Z	
27	1B	ESC	F6	CTRL+ [
28	1C	FS	F7	CTRL+ \	
29	1D	GS	F8	CTRL+]	
30	1E	RS	F9	CTRL+ ^	
31	1F	US	F10	CTRL+ -	
127	7F	␣	NP Enter		

Lower ASCII Reference Table

Note: Windows Code page 1252 and lower ASCII use the same characters.

Printable Characters								
DEC	HEX	Character	DEC	HEX	Character	DEC	HEX	Character
32	20	<SPACE>	64	40	@	96	60	`
33	21	!	65	41	A	97	61	a
34	22	"	66	42	B	98	62	b
35	23	#	67	43	C	99	63	c

Printable Characters (Continued)								
DEC	HEX	Character	DEC	HEX	Character	DEC	HEX	Character
36	24	\$	68	44	D	100	64	d
37	25	%	69	45	E	101	65	e
38	26	&	70	46	F	102	66	f
39	27	'	71	47	G	103	67	g
40	28	(72	48	H	104	68	h
41	29)	73	49	I	105	69	i
42	2A	*	74	4A	J	106	6A	j
43	2B	+	75	4B	K	107	6B	k
44	2C	,	76	4C	L	108	6C	l
45	2D	-	77	4D	M	109	6D	m
46	2E	.	78	4E	N	110	6E	n
47	2F	/	79	4F	O	111	6F	o
48	30	0	80	50	P	112	70	p
49	31	1	81	51	Q	113	71	q
50	32	2	82	52	R	114	72	r
51	33	3	83	53	S	115	73	s
52	34	4	84	54	T	116	74	t
53	35	5	85	55	U	117	75	u
54	36	6	86	56	V	118	76	v
55	37	7	87	57	W	119	77	w
56	38	8	88	58	X	120	78	x
57	39	9	89	59	Y	121	79	y
58	3A	:	90	5A	Z	122	7A	z
59	3B	;	91	5B	[123	7B	{
60	3C	<	92	5C	\	124	7C	
61	3D	=	93	5D]	125	7D	}
62	3E	>	94	5E	^	126	7E	~
63	3F	?	95	5F	_	127	7F	␣

Extended ASCII Characters					
DEC	HEX	CP 1252	ASCII	Alternate Extended	PS2 Scan Code
128	80	€	Ç	up arrow ↑	0x48
129	81		ü	down arrow ↓	0x50
130	82	,	é	right arrow →	0x4B
131	83	f	â	left arrow ←	0x4D
132	84	„	ä	Insert	0x52
133	85	…	à	Delete	0x53
134	86	†	å	Home	0x47
135	87	‡	ç	End	0x4F
136	88	^	ê	Page Up	0x49
137	89	%	ë	Page Down	0x51
138	8A	Š	è	Right ALT	0x38
139	8B	<	ï	Right CTRL	0x1D
140	8C	Œ	î	Reserved	n/a
141	8D		ì	Reserved	n/a
142	8E	Ž	Ä	Numeric Keypad Enter	0x1C
143	8F		À	Numeric Keypad /	0x35
144	90		É	F1	0x3B
145	91	'	æ	F2	0x3C
146	92	'	Æ	F3	0x3D
147	93	“	ô	F4	0x3E

Extended ASCII Characters (Continued)					
DEC	HEX	CP 1252	ASCII	Alternate Extended	PS2 Scan Code
148	94	”	ö	F5	0x3F
149	95	•	ò	F6	0x40
150	96	—	ù	F7	0x41
151	97	—	ù	F8	0x42
152	98	˜	ÿ	F9	0x43
153	99	™	Ö	F10	0x44
154	9A	š	Ü	F11	0x57
155	9B	›	ø	F12	0x58
156	9C	œ	£	Numeric Keypad +	0x4E
157	9D		¥	Numeric Keypad -	0x4A
158	9E	ž	£	Numeric Keypad *	0x37
159	9F	ÿ	f	Caps Lock	0x3A
160	A0		á	Num Lock	0x45
161	A1	ı	í	Left Alt	0x38
162	A2	ø	ó	Left Ctrl	0x1D
163	A3	£	ú	Left Shift	0x2A
164	A4	¤	ñ	Right Shift	0x36
165	A5	¥	Ñ	Print Screen	n/a
166	A6	ı	ª	Tab	0x0F
167	A7	§	º	Shift Tab	0x8F
168	A8	¨	¿	Enter	0x1C
169	A9	©	¸	Esc	0x01
170	AA	ª	¸	Alt Make	0x36
171	AB	«	½	Alt Break	0xB6
172	AC	¸	¼	Control Make	0x1D
173	AD		ı	Control Break	0x9D
174	AE	®	«	Alt Sequence with 1 Character	0x36
175	AF	—	»	Ctrl Sequence with 1 Character	0x1D
176	B0	º	•		
177	B1	±	•		
178	B2	²	•		
179	B3	³			
180	B4	´			
181	B5	µ			
182	B6	¶			
183	B7	·			
184	B8	¸			
185	B9	¹			
186	BA	º			
187	BB	»			
188	BC	¼			
189	BD	½			
190	BE	¾			
191	BF	¿			
192	C0	À			
193	C1	Á			
194	C2	Â			
195	C3	Ã			
196	C4	Ä			
197	C5	Å			
198	C6	Æ			
199	C7	Ç			

Extended ASCII Characters (Continued)					
DEC	HEX	CP 1252	ASCII	Alternate Extended	PS2 Scan Code
200	C8	È	ℒ		
201	C9	É	ℓ		
202	CA	Ê	ℓ̄		
203	CB	Ë	ℓ̄̄		
204	CC	ì	ℓ̄̄̄		
205	CD	í	=		
206	CE	î	≡		
207	CF	ï	≡̄		
208	D0	Ð	ℓ̄̄̄̄		
209	D1	Ñ	≡̄̄̄̄		
210	D2	Ò	ℓ̄̄̄̄̄		
211	D3	Ó	ℓ̄̄̄̄̄̄		
212	D4	Ô	ℓ̄̄̄̄̄̄̄		
213	D5	Õ	ℓ̄̄̄̄̄̄̄̄		
214	D6	Ö	ℓ̄̄̄̄̄̄̄̄̄		
215	D7	×	≡̄̄̄̄̄̄̄̄̄̄		
216	D8	Ø	≡̄̄̄̄̄̄̄̄̄̄̄		
217	D9	Ù	ℓ̄̄̄̄̄̄̄̄̄̄̄̄		
218	DA	Ú	ℓ̄̄̄̄̄̄̄̄̄̄̄̄̄		
219	DB	Û	■		
220	DC	Ü	■		
221	DD	Ý	■		
222	DE	Þ	■		
223	DF	ß	■		
224	E0	à	α		
225	E1	á	β		
226	E2	â	Γ		
227	E3	ã	π		
228	E4	ä	Σ		
229	E5	å	σ		
230	E6	æ	μ		
231	E7	ç	τ		
232	E8	è	Φ		
233	E9	é	Θ		
234	EA	ê	Ω		
235	EB	ë	δ		
236	EC	ì	∞		
237	ED	í	φ		
238	EE	î	ε		
239	EF	ï	∩		
240	F0	ð	≡		
241	F1	ñ	±		
242	F2	ò	≥		
243	F3	ó	≤		
244	F4	ô	∫		
245	F5	õ	∫̄		
246	F6	ö	÷		
247	F7	÷	≈		
248	F8	ø	°		
249	F9	ù	·		
250	FA	ú	·		
251	FB	û	√		

Extended ASCII Characters (Continued)					
DEC	HEX	CP 1252	ASCII	Alternate Extended	PS2 Scan Code
252	FC	ü	n		
253	FD	ý	²		
254	FE	þ	■		
255	FF	ÿ			

ISO 2022/ISO 646 Character Replacements

Code pages define the mapping of character codes to characters. If the data received does not display with the proper characters, it may be because the bar code being scanned was created using a code page that is different from the one the host program is expecting. If this is the case, select the code page with which the bar codes were created. The data characters should then appear properly.

Code Page Selection Method/Country	Standard	Keyboard Country	Honeywell Code Page Option
United States (standard ASCII)	ISO/IEC 646-IRV	n/a	1
Automatic National Character Replacement	ISO/IEC 2022	n/a	2 (default)
Binary Code page	n/a	n/a	3
<i>Default "Automatic National Character replacement" will select the below Honeywell Code Page options for Code128, Code 39 and Code 93.</i>			
United States	ISO/IEC 646-06	0	1
Canada	ISO /IEC 646-121	54	95
Canada	ISO /IEC 646-122	18	96
Japan	ISO/IEC 646-14	28	98
China	ISO/IEC 646-57	92	99
Great Britain (UK)	ISO /IEC 646-04	7	87
France	ISO /IEC 646-69	3	83
Germany	ISO/IEC646-21	4	84
Switzerland	ISO /IEC 646-CH	6	86
Sweden / Finland (extended Annex C)	ISO/IEC 646-11	2	82
Ireland	ISO /IEC 646-207	73	97
Denmark	ISO/IEC 646-08	8	88
Norway	ISO/IEC 646-60	9	94
Italy	ISO/IEC 646-15	5	85
Portugal	ISO/IEC 646-16	13	92
Spain	ISO/IEC 646-17	10	90
Spain	ISO/IEC 646-85	51	91

Dec			35	36	64	91	92	93	94	96	123	124	125	126
Hex			23	24	40	5B	5C	5D	5E	60	7B	7C	7D	7E
US	0	1	#	\$	@	[\]	^	`	{		}	~
CA	54	95	#	\$	à	â	ç	ê	î	ô	é	ù	è	û
CA	18	96	#	\$	à	â	ç	ê	É	ô	é	ù	è	û
JP	28	98	#	\$	@	[¥]	^	`	{		}	-
CN	92	99	#	¥	@	[\]	^	`	{		}	-
GB	7	87	£	\$	@	[\]	^	`	{		}	~
FR	3	83	£	\$	à	°	ç	§	^	μ	é	ù	è	..
DE	4	84	#	\$	§	Ä	Ö	Ü	^	`	ä	ö	ü	ß
CH	6	86	ù	\$	à	é	ç	ê	î	ô	ä	ö	ü	û
SE/FI	2	82	#	¤	É	Ä	Ö	Å	Ü	é	ä	ö	å	ü
DK	8	88	#	\$	@	Æ	Ø	Å	^	`	æ	ø	å	~
NO	9	94	#	\$	@	Æ	Ø	Å	^	`	æ	ø	å	-
IE	73	97	£	\$	Ó	É	Í	Ú	Á	ó	é	í	ú	á
IT	5	85	£	\$	§	°	ç	é	^	ù	à	ò	è	ì
PT	13	92	#	\$	§	Ã	Ç	Õ	^	`	ã	ç	õ	°
ES	10	90	#	\$	§	í	Ñ	¿	^	`	°	ñ	ç	~
ES	51	91	#	\$	·	í	Ñ	Ç	¿	`	´	ñ	ç	..
COUNTRY	Country Keyboard	Honeywell CodePage	ISO / IEC 646 National Character Replacements											

Keyboard Key References

6E	70	71	72	73	74	75	76	77	78	79	7A	7B	7C	7D	7E					
01	02	03	04	05	06	07	08	09	0A	0B	0C	0D	0F	4B	50	55	5A	5F	64	69
10	11	12	13	14	15	16	17	18	19	1A	1B	1C	1D	4C	51	56	5B	60	65	6A
1E	1F	20	21	22	23	24	25	26	27	28	29	2B				5C	61	66		
2C	2E	2F	30	31	32	33	34	35	36	37	39	53	5D	62	67				6C	
3A	3B	3C			3D				3E	3F	38	40	4F	54	59	63	68			

104 Key U.S. Style Keyboard

6E	70	71	72	73	74	75	76	77	78	79	7A	7B	7C	7D	7E					
01	02	03	04	05	06	07	08	09	0A	0B	0C	0D	0F	4B	50	55	5A	5F	64	69
10	11	12	13	14	15	16	17	18	19	1A	1B	1C	2B	4C	51	56	5B	60	65	6A
1E	1F	20	21	22	23	24	25	26	27	28	29	2A				5C	61	66		
2C	2D	2E	2F	30	31	32	33	34	35	36	37	39	53	5D	62	67				6C
3A	3B	3C			3D				3E	3F	38	40	4F	54	59	63	68			

105 Key European Style Keyboard

Sample Symbols

UPC-A

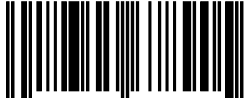

0 123456 7890

Interleaved 2 of 5

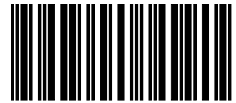

1234567890

EAN-13



9 780330 290951

Code 128



Code 128

Code 39

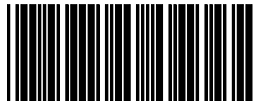

BC321

Codabar

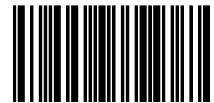

A13579B

Code 93



123456-9\$

Straight 2 of 5 Industrial

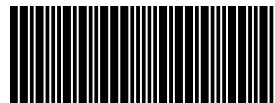

123456

Matrix 2 of 5



6543210

RSS-14



(01)00123456789012

Sample Symbols

PDF417



Car Registration

Postnet



Zip Code

QR Code



Numbers

Data Matrix



Test Symbol

Aztec



Package Label

MaxiCode

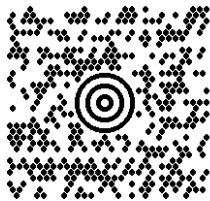

Test Message

Micro PDF417



Test Message

Programming Chart



Programming Chart



*If you make an error while scanning the letters or digits (before scanning Save), scan Discard, scan the correct letters or digits, and **Save** again.*

Honeywell

9680 Old Bailes Road

Fort Mill, SC 29707

www.honeywellaidc.com